

GENERAL LIBRARY  
APR - 9 1919  
UNIV. OF MICH.

# The Wireless World



**CONTENTS**

SENATORE MARCONI ON THE AMATEUR  
POSITION

ENEMY WIRELESS AT METZ

MODERN FIELD APPARATUS,  
WIRELESS IN ECUADOR, ETC.

Price **10<sup>D</sup>** NET

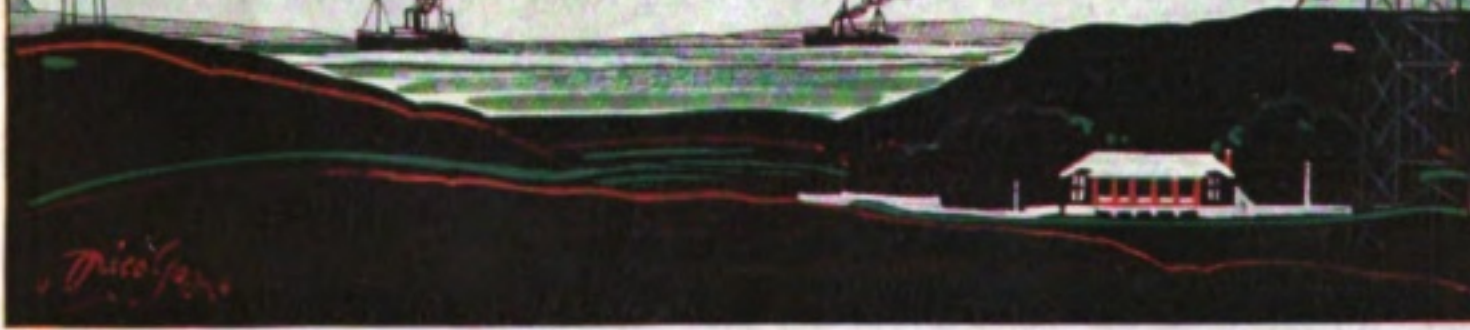



# SULLIVAN INSTRUMENTS

Sullivan "Universal" Galvanometers and Shunts for Land and Sea Use.

SULLIVAN TELEPHONE RECEIVERS.

Fast Speed Wheatstone Automatic Transmitters and Receivers, guaranteed at 400 words per minute, and Wheatstone Apparatus generally.

Precision and Standard Measuring Equipments for D.C. and A.C. (high frequency) determinations, Condensers of Low Power Factor, etc.

**H. W. SULLIVAN** WINCHESTER HOUSE, LONDON, E.C., ENGLAND.

Works: LIVERPOOL HOUSE, MIDDLESEX ST., LONDON, E.C.

Telegrams: "Deadbeat, London."

Telephone: Office: 3518 London Wall.  
Works: 4871 Avenue.

Silk and Cotton Covered H.C. Copper Wire, Resistance Wires, Fuse Wire,  
Binding Wires, Charcoal Iron Core Wire,  
Asbestos Covered Wire.

**P. ORMISTON & SONS, 79, Clerkenwell Road, London, E.C.1.**  
(P. H. ORMISTON.) "Ormiston, London" Established 1793. 13259 Central.

Braided and Twisted Wires,  
Bare Copper Strand & Flexibles of any Construction,  
Wire Ropes & Cords (fine sizes) in Galvanized Steel, Phosphor Bronze, etc.

**COMMERCIAL UNION**  
ASSURANCE CO., LTD.

Head Office:

24, 25 & 26, Cornhill, London, E.C.

The following classes of Insurance effected: FIRE, LIFE AND ANNUITIES, MARINE, LEASEHOLD REDEMPTION AND SINKING FUND, ACCIDENT, including Personal Accident, Third Party, Burglary, Plate Glass, Fidelity Guarantee, Employers' Liability and Workmen's Compensation, including Domestic Servants' Insurance. The Company also act as TRUSTEES AND EXECUTORS.

**FIRE, LIFE, MARINE, ACCIDENT.**

Capital fully Subscribed ... ..	£2,950,000
Capital Paid Up ... ..	£295,000
Total Assets (including Life Funds)	
31st December, 1913 ... ..	£24,902,252
Total Annual Income exceeds ... ..	£8,500,000

**THE BRITISH SCHOOL OF TELEGRAPHY, LTD.**

179, Clapham Rd., London, S.W.

Phone: BRIXTON 215.

**EXPERT TRAINING FOR YOUNG GENTLEMEN (15-25) IN INLAND, CABLE, & WIRELESS TELEGRAPHY.**

THIS old-established and up-to-date School is recognised by the War Office, Admiralty, Wireless Telegraph and Cable Companies as a training centre for Operators for their Services.

**GOOD APPOINTMENTS** are open to our students as soon as qualified, the demand for Skilled Operators in all Services being greater than the supply.

**SPECIAL COURSES** for men desirous of entering the Royal Flying Corps, Royal Engineers, Royal Naval Reserve and Royal Naval Volunteer Reserve (Telegraph Sections).

**SPEED PRACTICE** for improvers daily and three nights weekly.

**SPECIAL SHORT COURSE** suitable for men wishing to obtain Government Certificate and enter the service of the Marconi Co.

At several recent Government Exams. all candidates obtained 1st Class Government Certificate.

No Branches or Postal Tuition. Fees moderate. Write for Prospectus.

A. W. WARD (Manager).

Please mention "The Wireless World" when writing to Advertisers.

# THE WIRELESS WORLD

With which is incorporated "The Marconigraph."

A MAGAZINE DEVOTED TO WIRELESS TELEGRAPHY AND TELEPHONY

Registered at the G.P.O. for transmission by Magazine Post to Canada and Newfoundland.

**SUBSCRIPTION RATES.**—United Kingdom and British Empire (outside North America), 12s. per annum, post free; United States, Canada, and Newfoundland, \$3.00 per annum, post free; and Europe, fra. 15 per annum, post free.

Single copies, 10d. each, or post free 1s. 1d.

Articles submitted for acceptance by the Editor (which will be paid for on publication) should be addressed to Marconi House, Strand, London, W.C. No responsibility can be taken for MSS. or Photographs sent without stamps to defray cost of return postage.

Telegraphic Address: "Expense, Estrand, London." Tel. No.: City 8710 (10 lines).

## CONTENTS.

	PAGE
TECHNICAL ARTICLES.	
Recent Developments in Field Station Apparatus .. .. .	656
Digest of Wireless Literature .. .. .	663
German Wireless in Metz .. .. .	672
Valves .. .. .	678
The Design and Construction of Apparatus for the Wireless Transmission of Photographs ..	685
Instructional Article .. .. .	692
Questions and Answers .. .. .	700
GENERAL ARTICLES.	
Equatorial Wireless .. .. .	649
Personalities in the Wireless World .. .. .	654
The Amateur Position .. .. .	667
Communication with the Stars .. .. .	671
Notes of the Month .. .. .	676
Among the Operators .. .. .	680
Our April Issue .. .. .	682
Correspondence .. .. .	683
Wireless and Meteorology .. .. .	691
The Library Table .. .. .	697
Personal Notes .. .. .	699
MISCELLANEOUS ARTICLES.	
Additional Pay for Naval and Military Operators .. .. .	662
A New Japanese Station .. .. .	666
Pay for American Operators .. .. .	682
Share Market Report .. .. .	696

LICENSED BY H.M. POSTMASTER-GENERAL.

**DAY and EVENING  
CLASSES.**

**EAST LONDON WIRELESS TELEGRAPH COLLEGE**

172a & 228  
ROMFORD ROAD,  
FOREST GATE,  
LONDON, E.7

Established 1895.

Write for Prospectus.

**DAVIS & TIMMINS,**  
LIMITED,  
**KING'S CROSS,**  
**LONDON, N.**



Established 1876.

**METAL THREAD SCREWS**  
**Nuts, Bolts, Terminals &c.**

Telephone: North 580 (2 lines).  
Telegrams: "Conductivity, London."



**COMPAGNIE FRANCAISE MARITIME ET COLONIALE de TÉLÉGRAPHIE : SANS FIL :**

**Siège Social : 35, Boulevard des Capucines PARIS**

**Ateliers : 32, Rue de la Briche, St. Denis (Seine)**

**Construction, installation et exploitation de stations de télégraphie sans fil. Au premier Novembre, 1913, 80 stations de bord en exploitation.**

Transmission et réception des radiotélégrammes à bord des paquebots — S'adresser au télégraphiste du bord. S'adresser au Siège de la Compagnie, 35 Boulevard des Capucines, à Paris.

1°—Pour la transmission des radiotélégrammes à destination des paquebots en mer.  
2°—Pour la transmission par télégraphie sans fil (voie Marconi) des télégrammes à destination des Etats-Unis et du Canada.  
3°—Et pour tous renseignements.



**You May Know all about WIRELESS BUT**

there are many things you could learn to your advantage from **"THE AMATEUR MECHANIC"**

Written by skilled craftsmen in non-technical language, and fully illustrated by practical "How to do it" photographs and working drawings.

**Teaches 100 Arts and Crafts And Tells you all about—**

Wireless Telegraphy—Installing electric light—Making a reflex camera—Making incandescent mantles—Making a magneto electric machine—Ornamental cement and concrete—Fixing a speaking tube—Frosting glass—Nickel-plating—Metal working—Coloured metalwork—Altering gas fittings to take inverted burners—Making duplicating inks—Making a hectograph—To make a model flying machine—Making a gramophone—Repairing keyless watches—Clock cleaning—Fretcutting—Woodworking, simple and elaborate—How to use all kinds of tools—Stencilling and stencil cutting—To heat two rooms from one fireplace—All about door hinges—Gold and silver plating—Silvering and bevelling glass—Making and repairing furniture—Upholstery—How to mend windows—Hard soldering—Soft soldering—Repairing and adjusting typewriters—Electrotyping—Scene painting—To make a folding camera—Sign writing—To repair a hot water cylinder—Electric pole finding—etc.

**It also Shows You How to**

Paint and paper a room—Sole and heel and patch boots and shoes—Mount maps—Bind magazines and rebind old books—Make a pair of hand-sewn boots—Re-seat chairs—Make a wire bracket for placing over oil lamp or gas bracket so that fuel can be heated—Clean a Primus or other stove—Repair bicycles—Overhaul a motor car—Repair motor cycles—Repair water taps—Varnish a violin—Remedy damp walls—Repair the piano—Make a padded chair from an old cask—Mend penknives—Stuff animals—Dress furs—Stuff and mount birds—Do wood inlaying—Prepare working drawings—Read working drawings—Make a chemical weather-glass—Renovate a grandfather's clock—Make invisible ink—Use metal-drilling tools—Clean book-covers—Renovate mirrors—Erect tents—Build boats, canoes, etc.—Clean and repair locks—Take plaster casts—etc., etc.

Mr. T. F. GARNETT, B.Sc. etc., Goodmayes, writes:—  
"The books are of considerable practical utility in these days when 'mechanics' are all to the fore. My two sons, engineers in munition works, are much interested. One has made up his mind to start his own boot-repairing from the instructions given, while the younger is about to clean his watch. They consider that the articles on 'Turning,' 'How to Use the Micro-tom,' etc., are invaluable to all who wish to do well in munition or other bench work; and that is my opinion also."

**Send for the FREE BOOKLET**  
**No Charge and no obligation to order**

**To the Waverley Book Co., Ltd.**  
7, 8 and 9, Old Bailey, London, E.C.4.

Please send me, without charge or obligation to order, your Free Illustrated Pamphlet containing all particulars as to contents, etc., of "The Amateur Mechanic" also information as to your offer to send the Complete Work for a merely nominal first payment, the balance to be paid by a few small monthly payments, beginning thirty days after delivery.

Name .....  
Send this form or a postcard.

Address .....  
W.W.E. 1919.

Please mention "The Wireless World" when writing to Advertisers.



# The WIRELESS WORLD

Volume VI.

No. 72.

MARCH, 1919.



## Equatorial Wireless

*A New Station Erected at Sta. Elena, Ecuador*

By P. EISLER

ECUADOR furnishes a considerable proportion of those tropical products of which the great nations of the temperate zone demand more every year, and its progressive development is therefore a matter affecting world-wide interests. Its potentialities are great and immediate, for between the Cordillera Mountains and the sea there is room for untold profusion of cocoa, coffee and cotton plantations. In Guayaquil, moreover, the Republic possesses one of the finest harbours in South America.

Shipping already abounds in the neighbouring seas; and, in view of the fact that the Panama Canal is more and more taking on the character of a great international highway, each succeeding year is destined to witness an increase in the number of keels which furrow these placid waters. Yet no wireless of any importance served their needs until, in November, 1917, the station at Santa Elena Point was opened.

The installation was inaugurated by the Marconi Company, not directly under contract, but for experimental and demonstrational purposes. It was thought that no argument could be so conclusive to Government authorities in this part of the world as a station which would shepherd the vessels plying between their ports and the rest of the world, and which would prove by an object lesson based on actual experience the value of wireless telegraphy in opening up communications in undeveloped tropical regions. The result of this experiment has been encouraging in the extreme.

The locality selected for the site of the installation is a promontory which juts abruptly out into the Pacific Ocean a little under one hundred miles away from the city of Guayaquil. Past this promontory ply the vessels of three companies performing their steamship services on a regular schedule. These are: the Pacific

Steam Navigation Company (British), the Cia. Sud Americana de Vapores (Chilian) and the Cia. Peruana de Vapores (Peruvian). Over and above the regular lines numerous trading boats pass to and fro. All of these vessels, which carry wireless, can now maintain a regular traffic at any point along the seven hundred odd miles which stretch northward to the Isthmus, and a similar distance in the southerly direction.

The Galapagos Islands, lying out in the ocean about 600 miles to the westward, belong to the State of Ecuador; and it is hoped that communication will, through this wireless installation, be eventually maintained between this important group and the Republic which owns them. So far as the islands themselves are concerned, not merely are they remarkable for a distinctive flora and fauna, but—lying as they do on an ocean highway in the direct line from Panama to Australia and New Zealand—cannot but ere long assume that importance which must inevitably attach to a group so situated, enjoying in addition, as they do, the blessings of a perfect climate and fruitful soil.

The wireless gear was conveyed to Guayaquil and thence embarked on sailing



[Photo by H. F. Simmons.

AN OLD DUG-OUT RENDERED SEAWORTHY BY BALSA LOGS.

boats, locally known as *Balandras*, which ply along the seaboard here, engaged for the most part in the conveyance of salt from Sta. Elena to Guayaquil. The greater number of the *balandras*, as shown in our illustration on page 651, are fitted as cutters; although some of the larger craft, intended for more extensive voyages, have been schooner-rigged. From these sailing boats the material was landed on rafts (one of which figures in our illustration) constructed from a wood indigenous to these parts and known as *Balsa*. This timber is so light that a very substantial beam can be handled by a single man with great ease, and the Ecuadorians make extensive use of it for the purposes of flotation. In the case of the canoe utilised for landing our personal effects, which forms the subject of our illustration on this page, it will be noticed that the little craft, originally dug out from the trunk of a tree, had been rendered seaworthy by strapping a log of balsa to the side. The floating power of this light timber is made permanent use of at Guayaquil. Here we have a port  $2\frac{1}{4}$  miles long with a fine stretch of quays extending for over a mile and a half; and, as there are few piers for this great frontage, rafts of balsa wood have been put together to form a series of floating jetties, which cope adequately with the rise and fall of a tide averaging about 10 feet.



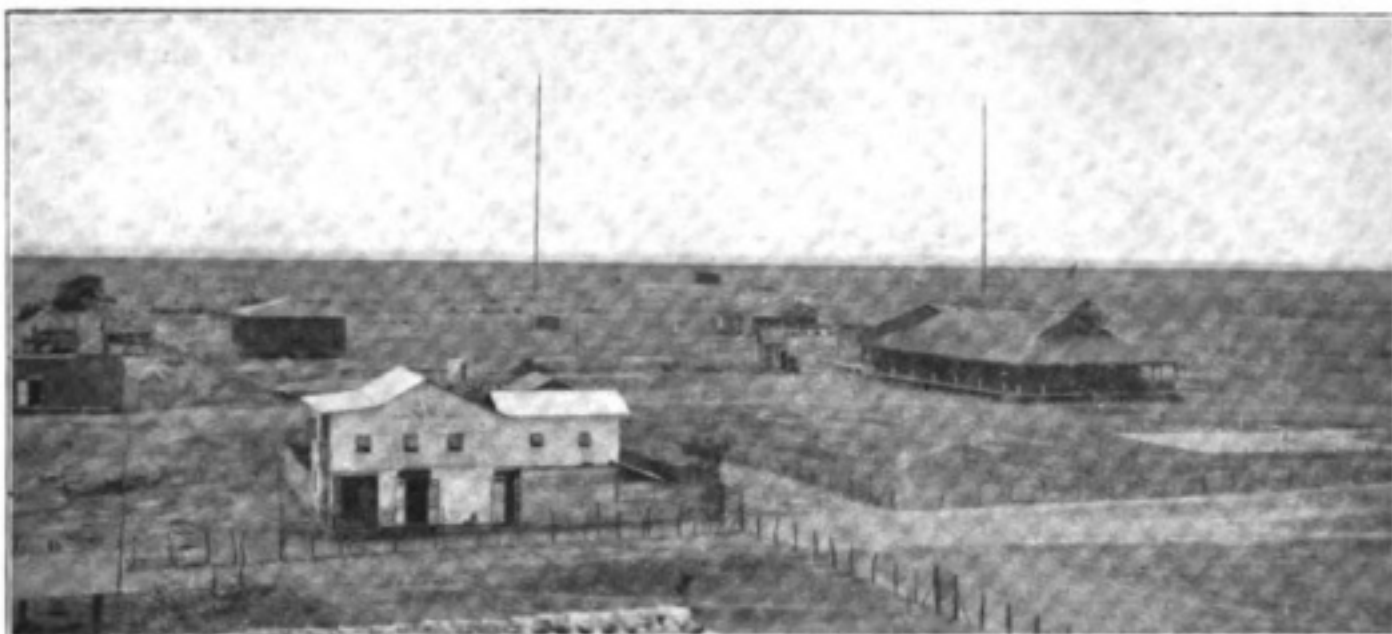

[Photo by H. F. Simmons.]

GENERAL VIEW OF STA. ELENA STATION WITH WIRELESS STATION IN DISTANCE.  
THE LARGE BUNGALOW TO THE RIGHT IS THE CABLE STAFF QUARTERS.

The soil with which we had to deal is sandy, and in close proximity to the sea, so that we encountered no difficulties in making good "earths." Our tubular masts were erected in stages of 10 ft., after a fashion indicated by our three illustrations. The lattice topmast, 40 ft. in length, was hoisted into position by a pair of sheer legs. Then three 10-ft. sections of tubular mast were bolted together around this topmast, leaving 10 ft. projecting. After this, before each 10-ft. section to the tubular mast was put into position, the topmast was raised 10 ft. to correspond. In order to execute this series of manœuvres, a moving cage was provided for the men to work on, as indicated in Fig. 1. The raising of the topmast was effected by utilising a steel rope passing through a sheave in the heel of the topmast itself and carried out to a winch. Thus the construction proceeded from stage to stage, until we had attained the desired height. Fig. 3 shows the men going aloft to work in the cage, at one of the later stages.

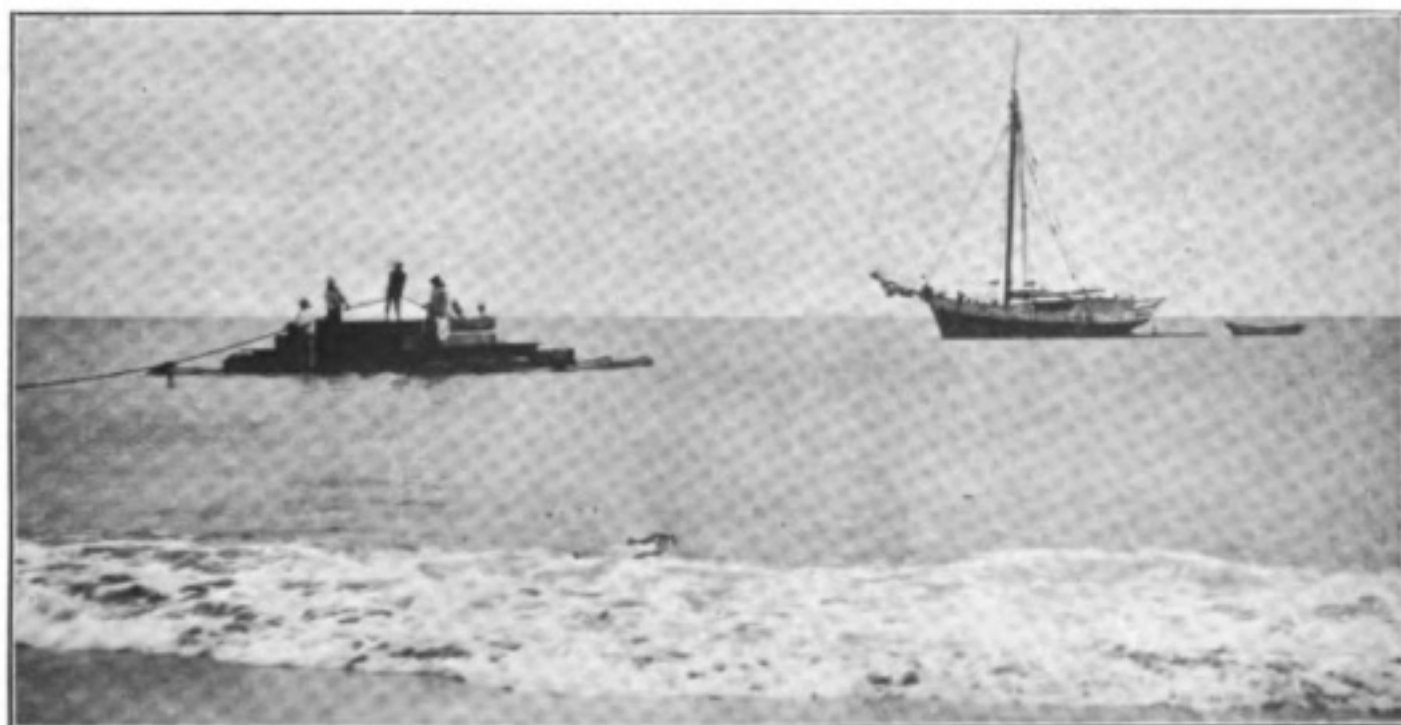

[Photo by H. F. Simmons.]

LANDING GEAR FROM A BALANDRA.

At Sta. Elena the height of our two masts runs to 260 ft. and they are placed 600

ft. apart. The power of the installation amounts to 5 kw. and radio-telegraphic operating is conducted on wave-lengths of 600, 1,000 and 2,000 metres. The engines are of 10 h.p. and driven by petrol, which is obtainable at quite reasonable rates from the neighbouring Peruvian oil fields. Ere long it may be possible to secure all that is required from the immediate neighbourhood, which is itself petroliferous and contains a number of surface wells already worked by the local inhabitants. The illustration on the opposite page gives a general view of the wireless machinery, and the installation has been equipped with receivers of the latest magnifying-valve type, capable of reception up to 4,000 metre waves.

The country which lies between Sta. Elena Point and Guayaquil is thickly wooded, with tangled tropical vegetation, and communication overland can only be maintained by means of a rough track through the virgin jungle, available for motor-cars during the dry season of the year; all through the rest of the twelve months communication is possible solely by sea.

The climate of the two places differs considerably, that of the great seaport being hot and oppressive, whilst Sta. Elena's temperature is modified by prevalent cooling breezes from the south-west. This advantage the latter owes partly to its situation with regard to the sea, and partly to the fact that it lies at the tail end of the great Humbolt current. These superior climatic conditions have caused the little seaside village to be extensively used as a watering place, or *Balneario*, by Guayaquil citizens, many of whom own the unpretentious bungalows which may be seen dotted along the sea front.

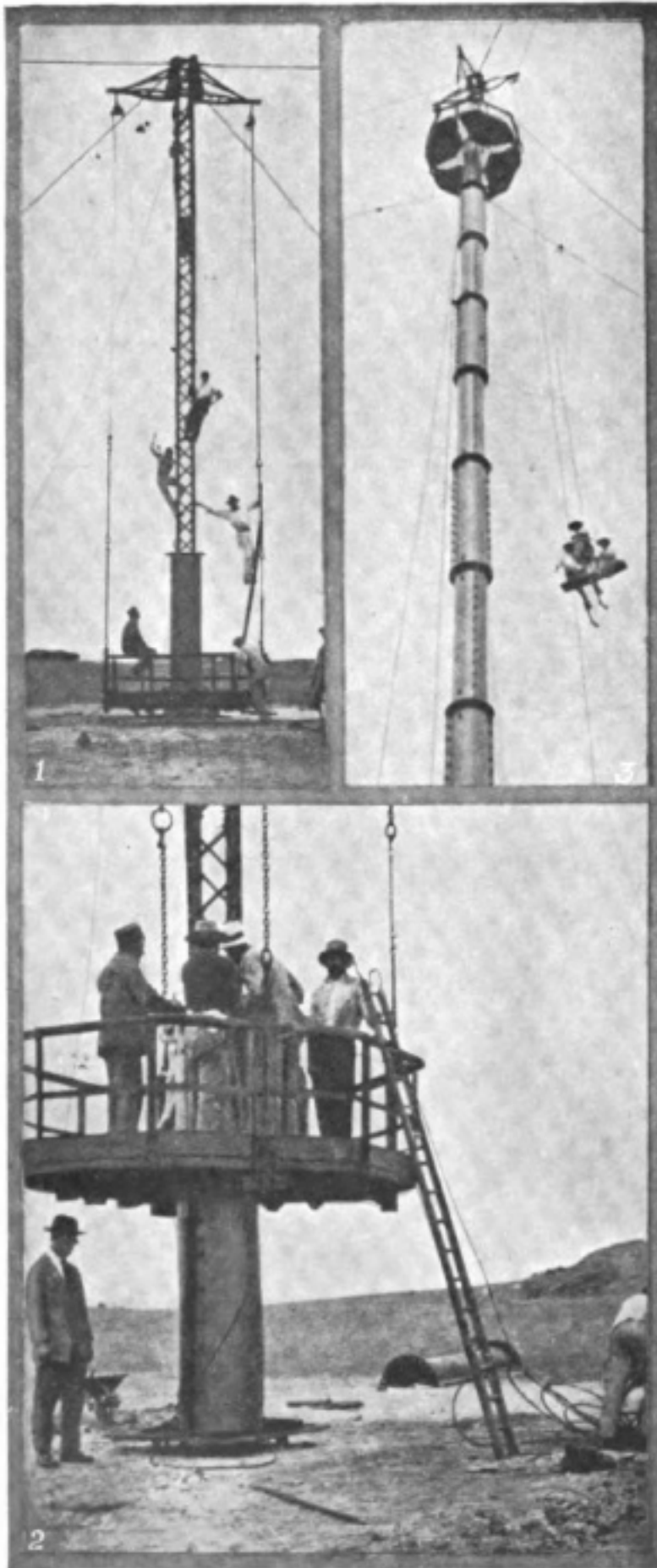

[Photo by H. F. Simmons.]

RAISING THE AERIAL MASTS: (1) THE FIRST STAGE; (2) THE LOWER SECTION WITH "MOVING CAGE"; (3) MEN BEING HOISTED INTO THE CAGE



The first wireless telegraph station ever established in Ecuador was installed in 1913 at Guayaquil by Señor Don George Chambers Vivero, Captain of the Port. It was erected on his private initiative and at his own expense, for the purpose of communicating with vessels navigating in the Guayaquil river. Through its intermediary this enterprising and energetic official is able to maintain touch with the newly-erected station at Sta. Elena. The instruments of this miniature installation are worked by an Ecuadorian operator, who manages the communications in a thoroughly satisfactory manner. The technical proficiency requisite for wireless operating is well within the natural capacity of the citizens of the Republic, despite the fact that the average education prevalent within its borders does not attain so high a level as could be desired.

An eloquent object-lesson in the importance of wireless for opening up communication in relatively undeveloped countries such as this, is furnished by the inter-relations between Quito, the capital of the Republic, and Guayaquil, its principal port and chief commercial centre. The two cities are separated by about a distance of 200 miles, which is spanned by a telegraph wire. Yet, despite the importance of maintaining constant intercourse between the two most important cities of the State, telegraphic communication is not infrequently interrupted for days together. This constant interruption is owed to a multiplicity of causes, some natural, some human. Probably the most serious destruction is due to the agency of heavy rains, whose tropical violence, during certain seasons, uproots considerable tracts of the line. Then, too, the mountain folk find telegraph wire of considerable utility to them in various ways, and do not hesitate to help themselves to State property irrespective of consequences. The net result is that the maintenance of this vital line of communication causes a perennial loss, which I have heard computed by competent authorities at no less than £15,000-£20,000 per annum. Indeed, it has been stated in my hearing that, so soon as wireless communication between these two centres has been opened, the present wired lines will be allowed to fall into complete disuse.

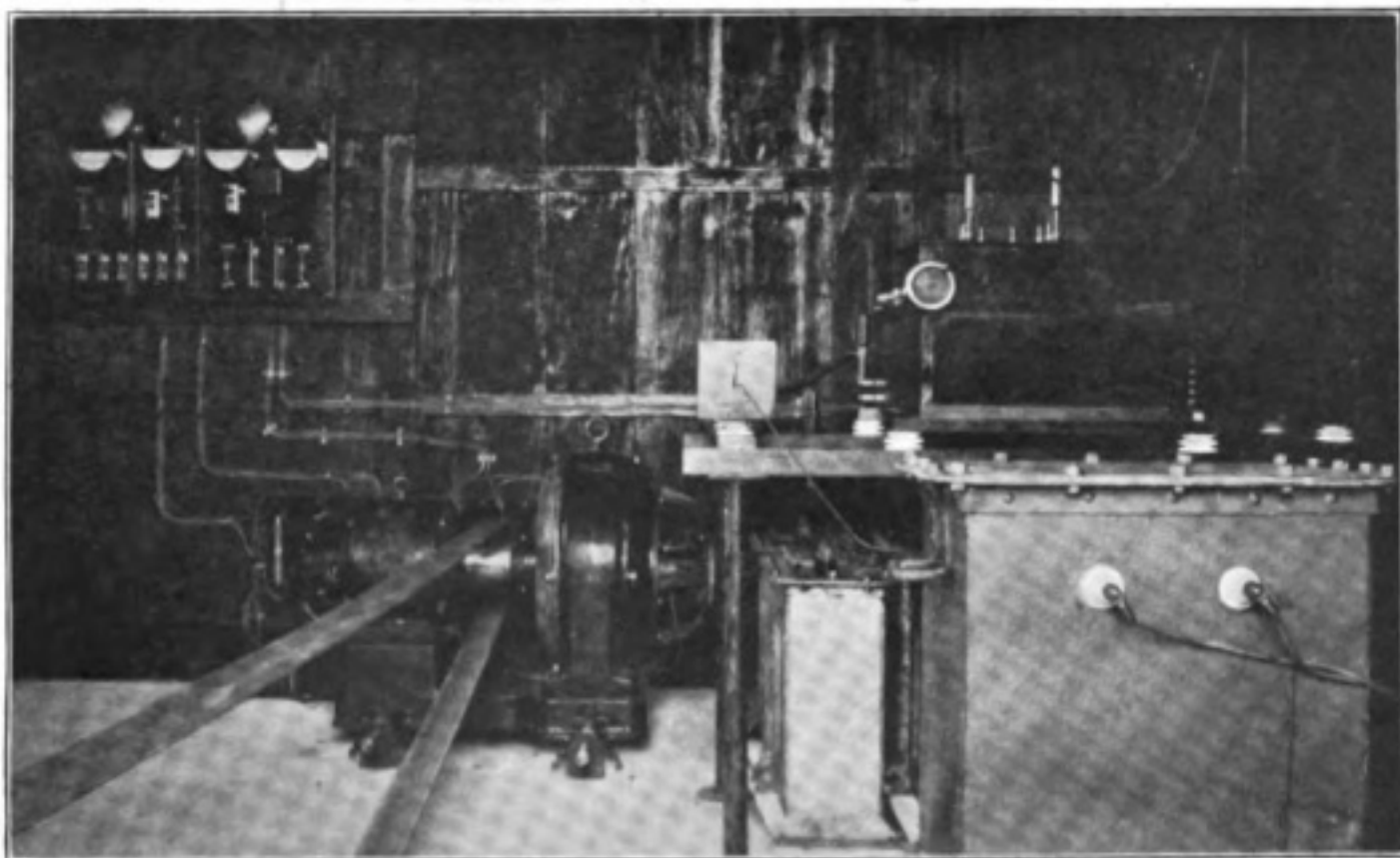

[Photo by H. F. Simmons.]

CORNER OF ENGINE ROOM, SHOWING TRANSMITTING APPARATUS

# PERSONALITIES IN THE WIRELESS WORLD



CAPITAIN de GENIE BRÉNOT





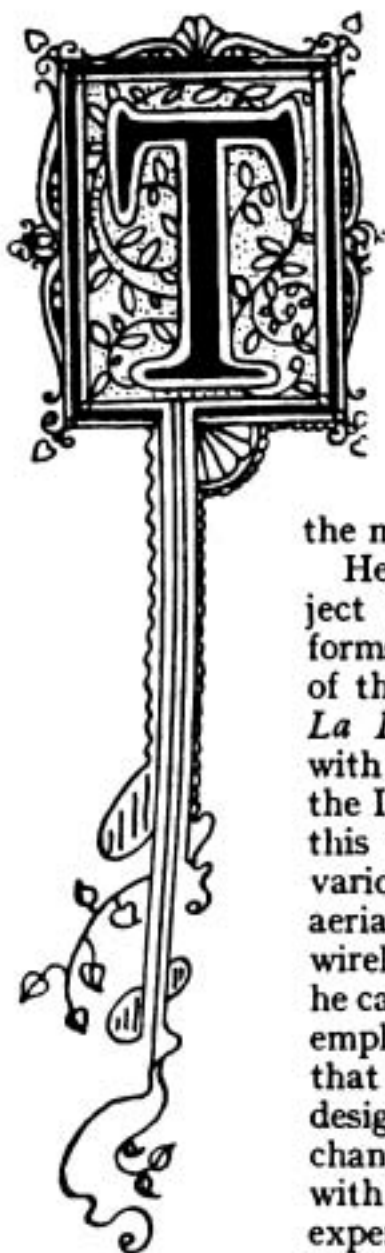

HE subject of our notice this month was born at Ruoms, in the Department of the Ardèche, on September 19th, 1880. Educated first at the Ecole Polytechnique and at the Ecole d'Application of Fontainebleau, he quitted the latter establishment in 1903, and was granted a commission as Engineer-Lieutenant in the Telegraphists' Division at Fort Mont-Valerien. In 1910 he transferred to the Central Establishment of Radiotelegraphy, and supervised the installation of wireless at most of the military stations, both permanent and mobile.

He specialised in research work, having for its subject the various types of crystal detectors (certain forms of which are due to his suggestion) and some of the results of his labours have been published by *La Lumière Electrique*. In 1908 he was entrusted with the task of representing wireless telegraphy at the International Electrical Congress at Marseilles. At this time also he collaborated with M. Blondel in various investigations into the employment of frame aerials for radiogoniometry, and high tension arcs for wireless telegraphy and telephony. In 1910 and 1911 he carried through some important experiments on the employment of wireless telegraphy in aircraft. At that time with an aeroplane carrying a crew of two, designed for a two-hour flight, messages were interchanged over a distance of 40 kilometres, the station with all its accessories weighing 25 kilograms. These experiments gained for their originator the Cross of the Legion of Honour.

Captain Brénot was, before the war, in charge of the pages devoted to wireless telegraphy and telephony in the *Revue Générale d'Electricité*, besides being head of the practical work in the advanced wireless school. In 1911 he was appointed as Technical Adviser to the Minister of the Colonies, and took over the organisation of the Colonial Systems, particularly those applying to communication between the various Colonial units. This system includes 35 installations in actual working, 25 in course of construction and 30 in contemplation. Six of those now building are high-power stations. He acted as Delegate of the Colonial Office at the International Radiotelegraphic Conference of London in 1912, at the International Time Conference of Paris (1912-1913), and at the International Safety-at-Sea Conference held in London in 1913-1914. During the war, whilst remaining in charge of French Colonial Wireless, he was appointed Head of the Radiotelegraphic Centre at Paris and of the Eiffel Tower Station.

# Recent Developments in Field Station Apparatus

## *Damped and Continuous Wave Transmitters and Receivers*

WITH the removal of censorship restrictions we are now able to deal in this magazine with some of the technical details of wireless apparatus in use throughout the war. In view of the interest which has been aroused by the accounts of Army wireless work in the field, we think our readers may appreciate a description of some of the more modern field-station apparatus produced by the Marconi Company, and we therefore propose in this article to deal with the  $1\frac{1}{2}$ -2 kw. waggon station, known as Type F2.

In the design of wireless apparatus for the field we have to take into account several important considerations which are negligible in the case of fixed stations, such as those which are used for communication with ships at sea. In the latter case portability and speed of erection are virtually unimportant, whereas, in the case of a wireless station erected in the fighting area these are primary considerations. Let us first, then, consider this particular set of apparatus from the standpoint of portability.

The station is carried by two carriages of the limber and waggon type, each

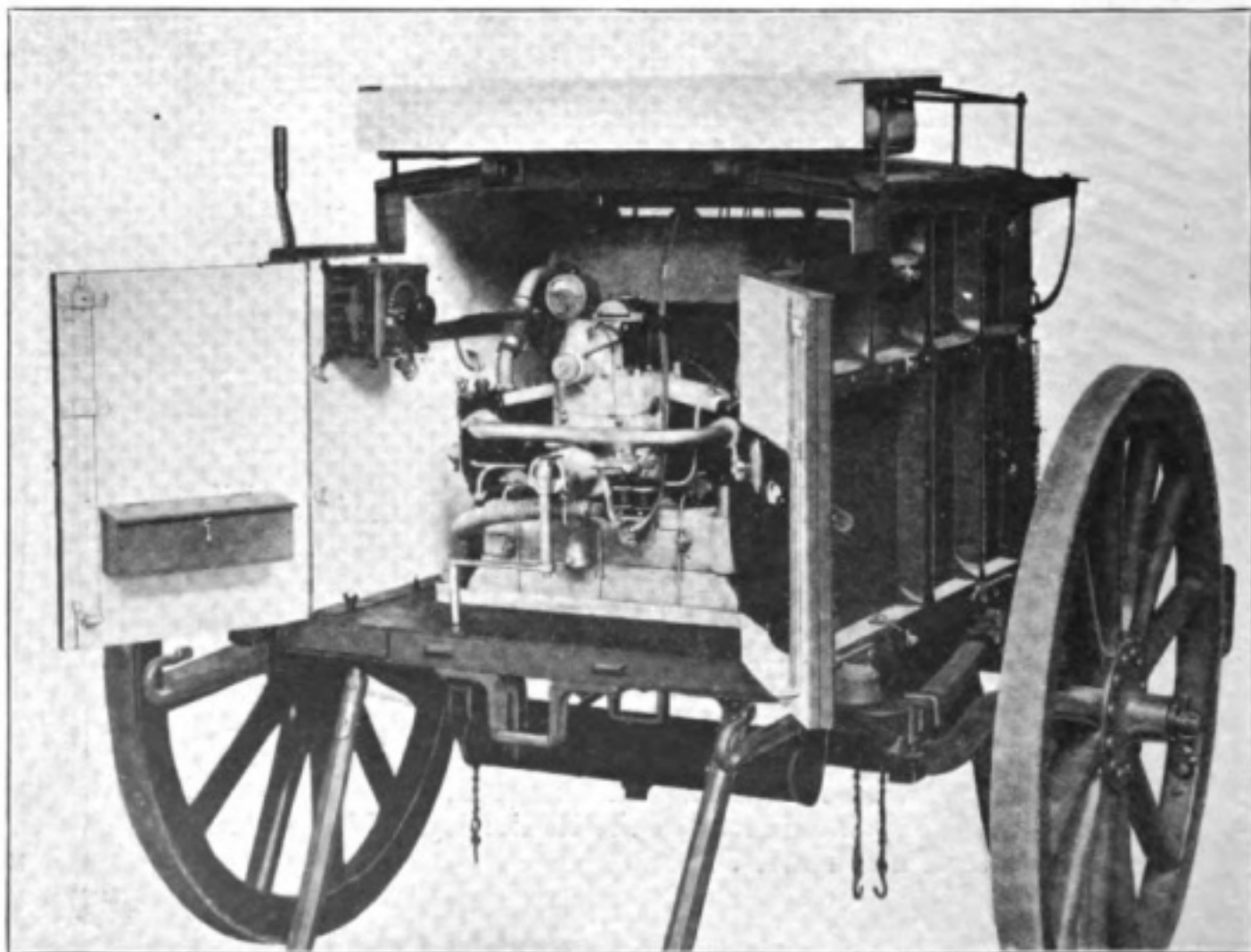

THE POWER CART.  $1\frac{1}{2}$ -2 KW. CART SET.



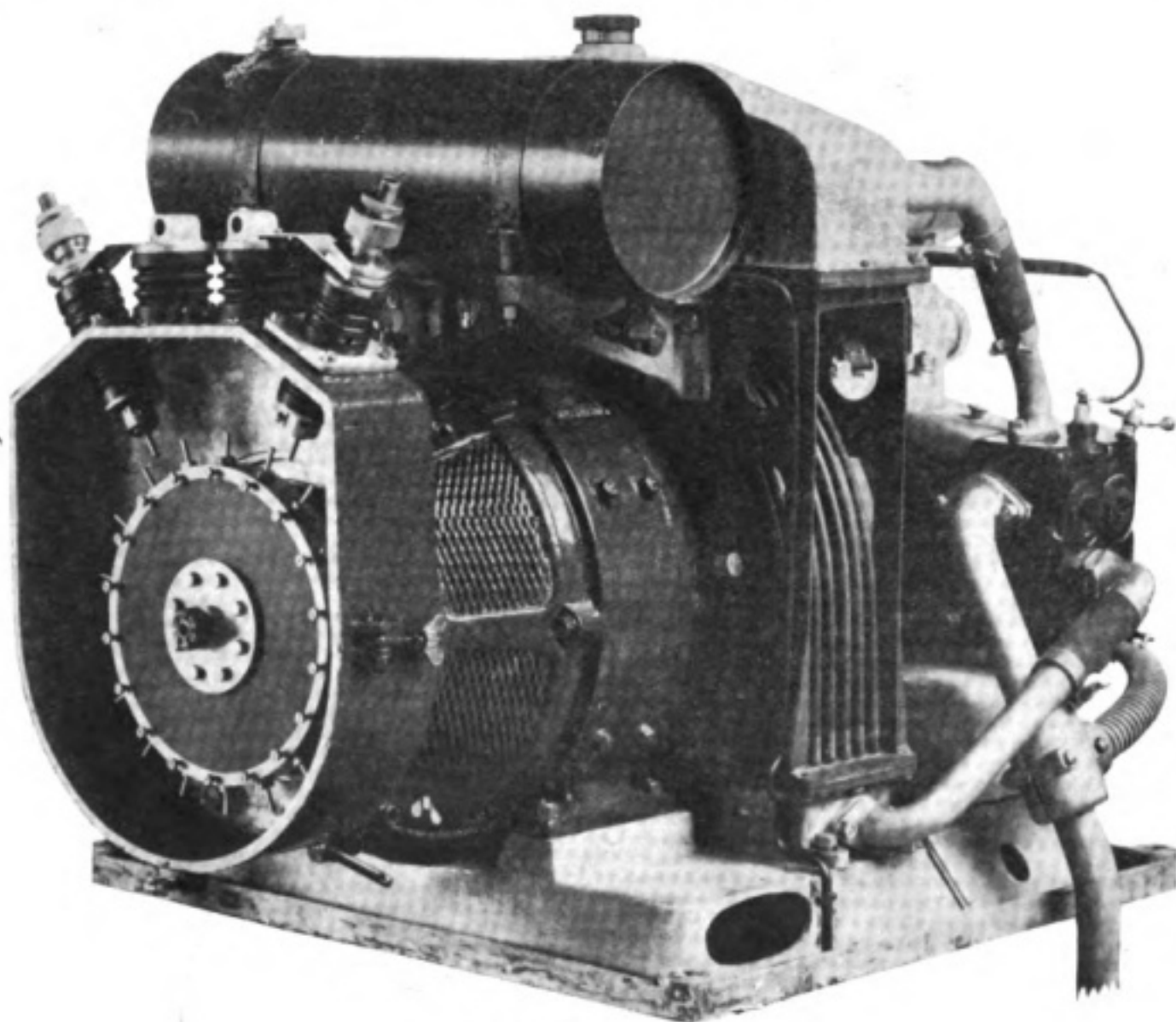

THE GENERATING SET.

carriage being drawn by four horses. The weight of each carriage complete, but without personnel, is about 29 cwt., and the total gross weight, including personnel, is in the neighbourhood of 69 cwt. The carriages, of which a good general idea can be gained from illustrations on the previous page and page 659, are solidly constructed with wheels 5 ft. in diameter and  $3\frac{1}{2}$  in. tread fitted with artillery-pattern naves and bushes. The axles are solid steel forgings and are cranked 5 in. to bring the centre of gravity of the carts as low as possible. A brake is fitted to each cart, and the footboards, being removable, are so arranged as to form a seat for the operator when the station is working.

The personnel normally consists of eight men, and with a full complement the station can be erected and in action within twenty minutes of halting and can be dismantled and packed within fifteen minutes. In emergencies, however, the station can be erected and worked by a minimum of two men.

The station, when erected, is seen to possess two masts, which are of the steel tube sectional type, 70 ft. in height and supporting a horizontal antenna of the simplest possible design, allowing easy erection in any locality without the necessity of having to look for a large piece of open ground such as would be necessary to erect an umbrella antenna. The earth connection is also of the simplest possible type, and, being laid on the ground, does not interfere with the freedom of approach to the station.

The first carriage or engine cart illustrated on page 656 carries the generating set, together with the necessary fuel and oil tanks, switchboard and connectors.

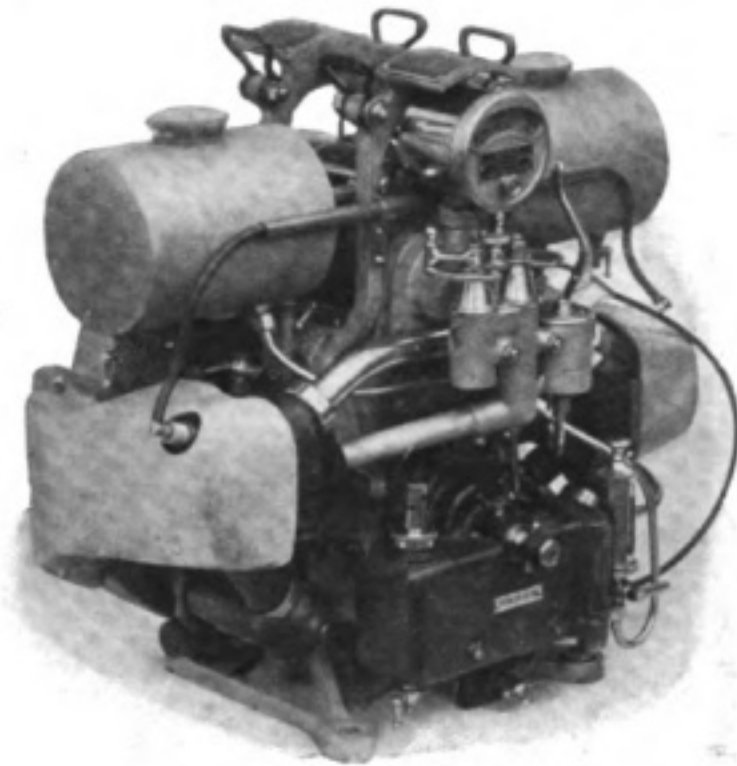

AN AIR-COOLED MOTOR.

The prime mover consists of a slow-speed petrol engine running at 1,200 revolutions per minute. Using a special aluminium alloy wherever practical and the very best materials obtainable, and by the careful design of the various component parts, the weight of the engine has been kept low while allowing a high factor of safety. To ensure steady running with a minimum of vibration a type of engine with horizontally opposed cylinders and cranks at  $180^\circ$  has been adopted. All moving parts are most carefully balanced, and the absence of vibration at all speeds is remarkable. All parts of the engine are made to gauge and can therefore be very easily replaced. In order to ensure efficient running under all conditions

the engine has been designed to give 8 h.p., a water-cooling system being adopted. The cooling system consists of water jackets cast with the cylinders connected by suitable pipes to a large radiator, and permits cool work under the most adverse climatic conditions. A strong current of air is maintained through the radiator by means of a fan attached to the fly-wheel. The radiator is of the tubular type and is extremely simple and robust, and can be cleaned out very thoroughly should occasion require it. For use with pack stations in hot climates and in conditions where water is not readily available an air-cooled type of machine is made, and this is shown from two points of view on this page. The most modern form of high tension magneto ignition has been fitted in such a way as to ensure ready adjustment without detaching it from the engine. Lubrication has been reduced to its simplest form and rendered entirely automatic by means of a screw pump delivering to troughs into which the big ends dip, so that a supply is given as long as the engine is running and is shut off when the engine stops. The cylinders, which are  $3\frac{1}{2}$  in. by  $3\frac{1}{2}$  in., are bolted to the crank case and are easily detachable, while the pistons are fitted with two rings and lightened as much as possible. The gudgeon pin is a driving fit in the piston, the cylinders being protected from accidental damage by the pin by means of copper caps, pressed into the gudgeon pin-holes. The crank shaft is made from a special 3 per cent. nickel steel stamping and runs in ball bearings, and the valves, which are of nickel steel turned from the solid, are readily accessible by removing the valve covers.

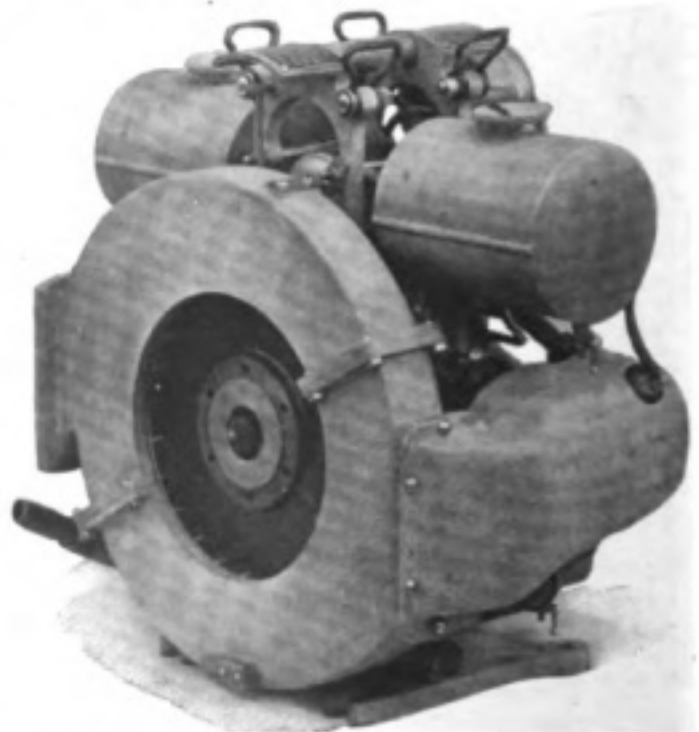

THE SAME FROM ANOTHER ANGLE



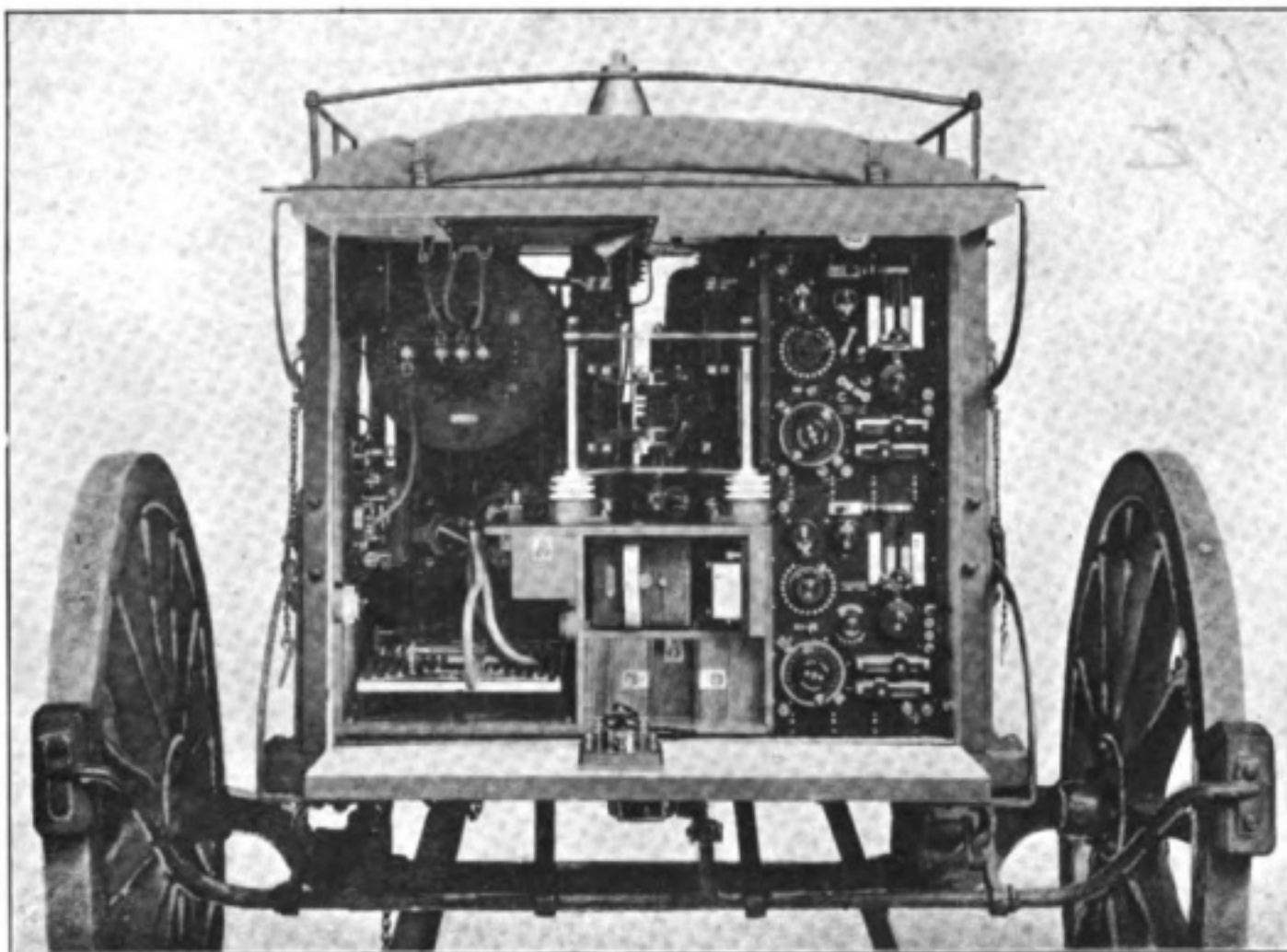

THE OPERATING CART.

Both inlet valves and exhaust valves are mechanically operated direct from the cam shaft without intermediate rockers and are interchangeable.

Directly coupled to the petrol motor is an 18-pole self-exciting generator, designed for an output of 12.5 amperes at 200 volts alternating current, and 7 amperes at 25 volts direct current, the latter being valuable for charging the accumulators used for the electric lighting of the carts and for the receivers. The end of the dynamo shaft, remote from the coupling, is prolonged sufficiently to carry the disc discharger (seen in our illustration on page 657), and a light aluminium casing extends from the end cover of the generator, which at the same time carries the fixed electrodes of the disc discharger, totally enclosing the latter and thus reducing the noise of the spark to a minimum and protecting the disc discharger from damage. The generator is driven by the engine through a flexible coupling.

Two switchboards are fitted to this set; the alternating current board, consisting of a slate panel on which is mounted a 2-pole main switch, two fuses and two guard lamps. The direct current switchboard consists of a slate panel containing a main switch, an automatic cut in and cut out, an ammeter and a voltmeter, a fuse and two guard lamps. Connections are made between the carts by armoured leads and interchangeable plugs and sockets. The plugs are of extremely strong design, ensuring thoroughly reliable connections so arranged that it is impossible to connect the circuits inaccurately. Electric lighting is provided in both the engine and instrument carts, the current being provided by the accumulators, which are automatically charged by the dynamo whenever the engine is running.

Considering in detail the transmitting apparatus, we find that the transformer is of the closed iron circuit type, the seconding being connected through protecting chokes to the two electrodes of the discharger, across which a fixed safety spark gap is placed to prevent any excessive strain being put on the transformer or condenser

battery due to faulty adjustment of the disc. The primary high-frequency circuit consists of a condenser battery, disc discharger, primary jigger winding, operated by a 2-way switch, and fixed primary inductance, a primary tuning inductance with four adjustable tubes, and a 4-way change-tune switch. The condenser consists of 22 tubes of specially selected glass, with an electrically deposited copper coating both inside and outside each tube. The tubes are calibrated to a definite capacity, so that in the case of a breakdown a new tube may be inserted without disturbing the electrical balance of the circuit, but, being extremely strong, they are not likely to break down save in exceptional circumstances.

The jigger primary consists of four turns of a specially insulated cable of very high conductivity. A tapping is taken from the first turn of this winding and a 2-way switch is provided, by means of which either one or all four parts of the jigger primary winding and the fixed primary inductance can be connected in the oscillatory circuit. The primary tuning inductance consists of a flat spiral of silver-plated copper strip mounted in such a way that connection can be made to it at any point. The inductance winding is marked progressively and a calibration table is provided showing the wave-lengths corresponding to the various points of adjustment. Four conductors are brought through ebonite tubes to the inductance from the change-tune switch, each conductor ending in a convenient spring clip by means of which it can be attached to any point of the inductance. The change-tune switch, to which reference has been made above, is used for connecting the disc discharger to the various points on the primary tuning inductance, thus including more or less all the inductances in the primary circuit and so varying the wave-length. This switch is mechanically connected to a similar switch in the secondary circuit, so that only one movement is required to change both the primary and secondary high-frequency circuits, thus making it possible instantaneously to change the wave-length from one pre-determined value to another. The particular value of this feature lies in the fact that by pre-arrangement two stations working together can decide to change their wave-length at certain time intervals, or after certain words, and any

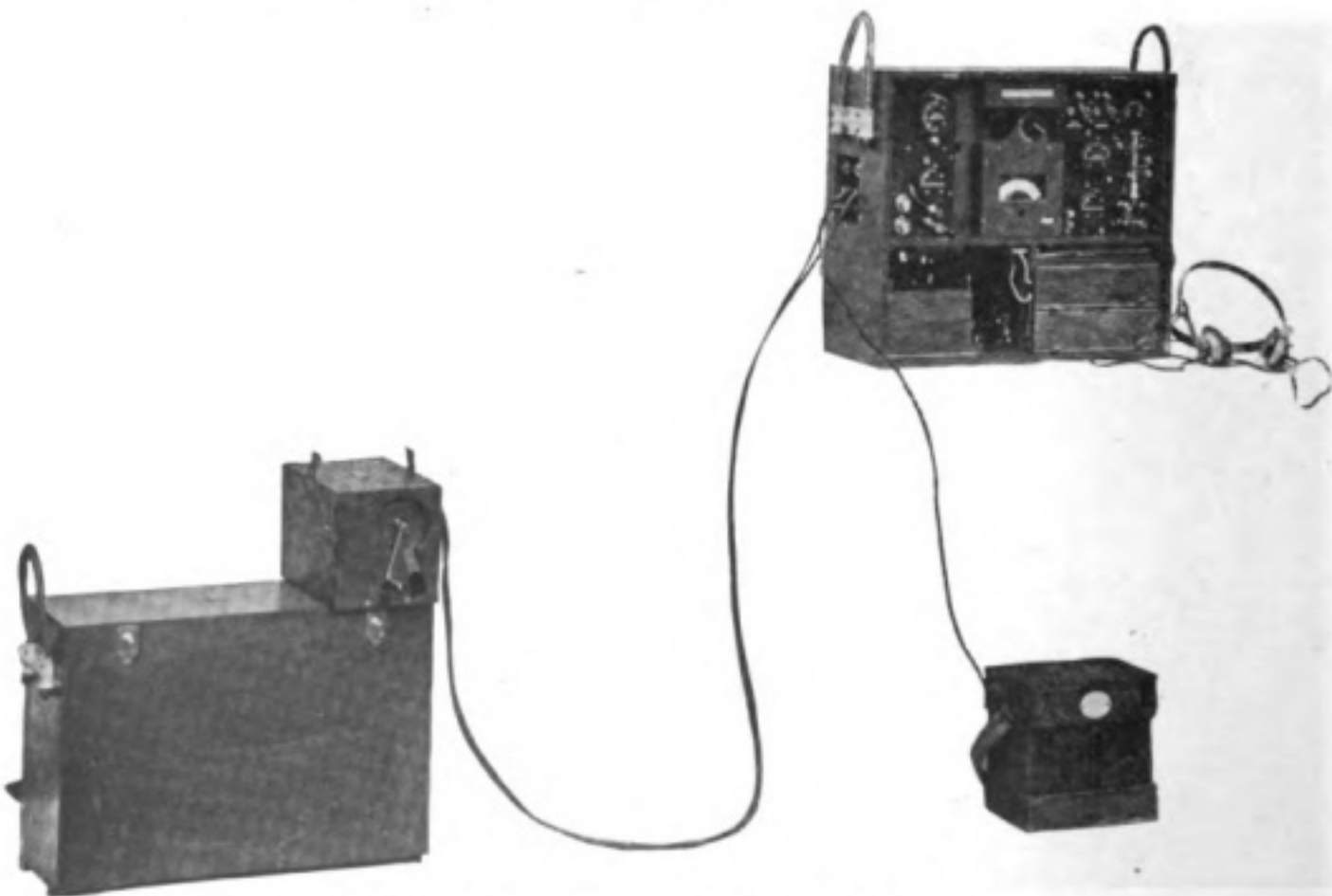

A PORTABLE CONTINUOUS-WAVE TRENCH SET.



station endeavouring to intercept is thereby confused and delayed while it picks up the new wave-length. By the time it has found this latter it is possible by means of the switch to change once again to another adjustment, whereupon the intercepting station has to commence its work over again.

The relative position between the fixed electrode and the disc of the disc discharger can be varied by a screw adjustment, thus ensuring that the discharge takes place at the moment when the secondary alternating current voltage is at its maximum. Once this position has been found no further adjustment is required.

A blower fitted behind the discharger casing keeps up a constant circulation of air through the casing, thus carrying off the gases formed by the discharge. Connection is made from the disc discharger to the instrument cart by means of two highly insulated and protected conductors which run along the perch pole between the limber and the waggon.

The secondary or aerial circuit consists of a horizontal "T" aerial, an aerial tuning inductance, a jigger secondary and an earth connection. The jigger secondary is mounted in front of the jigger primary on a former, which can be moved towards the primary for the purpose of varying the coupling. Three conductors fitted with suitable plugs for attaching to the connection pillars are brought from one side of the change-tune switch, one of the conductors being common to two pillars on the switch. A fourth conductor connects the one end of the winding to the anchor spark gap. An aerial ammeter is connected to an inductive shunt in the aerial circuit between the jigger secondary and the earth connection, and a small sparking coil is mounted close to the anchor spark gap and can be used either for producing oscillations in the aerial when it is required to measure the wave-length of the aerial circuit or for transmitting over a distance of a few miles to save the running of the generating set.

On the receiving side two entirely separate receivers are provided. Both receivers are of similar design and are arranged for quick and easy adjustment to any wave-length within their respective ranges. The ranges of the receivers overlap one another considerably and so provide a duplication. In general design they are of the two-circuit form, being thus chosen for simplicity of operation as well as efficiency of arrangement. Two separate and independent detectors are provided with each receiver, each detector circuit consisting of a crystal, battery and potentiometer for adjusting the crystal to its most sensitive point and fitted for two pairs of high-resistance telephones which are common to both detector circuits. Arrange-

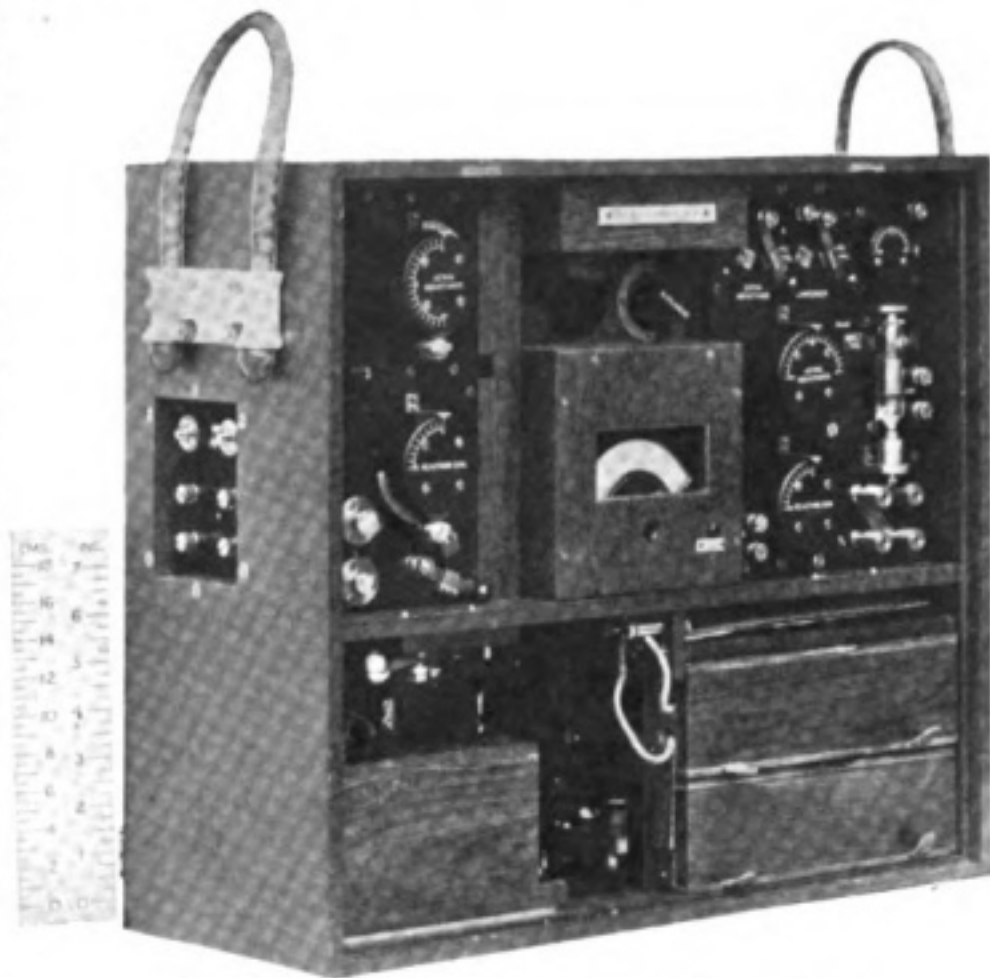

A CLOSER VIEW OF THE C.W. TRENCH SET.

ments are made so that both crystals may be used together for opposed crystal working, which has the advantage of reducing the noise of atmospheric disturbance to a minimum.

The general arrangement of the receivers, as well as much of the transmitting apparatus, can be seen from our illustration on page 659. With the detectors described and with a pair of similar stations working to one another the range can be guaranteed for 150 miles over a normal flat country. In most cases, however, considerably greater ranges than this may be obtained, the guaranteed figure being, of course, much less than that obtained normally. With the Marconi amplifying receivers, which are fitted when required, the guaranteed range can be at least doubled.

For both transmitting and receiving the earth connection consists of four nets of copper wire gauze, each net being provided with a string flexible connecting wire ending in a metallic plug which fits into the sockets at the corners of the instrument cart. This form of earth connection has been adopted as being a far more practical arrangement than the "capacity earths" which cover the surroundings of the station with insulated wires supported at such a height that they interfere with the approach of horses or men, besides giving shocks to those who are unfortunate enough to touch them.

Another extremely interesting and highly portable Marconi field set is shown in our illustration on pages 660 and 661. This particular set of apparatus is designed to transmit and receive continuous waves, the power for working the transmitter being provided by a hand-driven dynamo, shown attached to the box on the left-hand side of the illustration on page 660. The guaranteed range of this station is 45 miles, or double this with amplifying valve receivers. The latter apparatus is carried by two horses, the load per horse, exclusive of saddle, being approximately 160 lb. Two steel masts are provided 15 ft. high and supporting a single wire horizontal aerial 70 ft. long. The transmitting and receiving apparatus is entirely self-contained in one case and forms one-half of the instrument load, the other half consisting of two 40 ampere hour 6 volt accumulator batteries to be used for both the transmitter and receiver filaments. The high tension current for the transmitter is supplied by a hand-driven generator with an output of 20 watts at 1,500 volts. The high-tension current for the receiving valves is supplied by a small dry cell battery, two of which, one for spares and one for use, are carried in the instrument box. On page 661 a closer view is given of the instrument box. On the left the upper switch, marked in degrees, is the aerial inductance, while the lower is the reaction coil. Transmitting valves are contained in the centre of the case, while the receiver, with its detecting valve containing switches and telephone plugs, are shown on the extreme right. The remarkable compactness of the whole apparatus is admirably indicated by the measuring-rule shown at the side.

## Additional Pay for Naval and Military Operators

THE bonus scheme of additional payment to Military and Naval men of both commissioned and non-commissioned rank was welcomed by the wireless men of these services equally with the other ranks and ratings. Under the new arrangement additional remuneration is paid varying in the Army from 10s. 6d. per week for a private to double that amount for a warrant officer, class 1; and in commissioned ranks from 24s. 6d. per week for 2nd lieutenants to 42s. per week for ranks over that of lieutenant-colonel.

In the Navy, boys receive 6d., ordinary seamen, 1s.; A.B.'s, 1s. 6d.; and leading seamen, 1s. 9d. per day; while petty officers, C.P.O.'s, and warrant officers receive 2s., 2s. 6d., and 3s. 6d. per day extra pay, respectively. Commissioned warrant officers and mates under the new scheme receive 4s.; sub-lieutenants, 2s.; lieutenants, 4s. 6d.; and lieutenant commanders, 5s. 6d. Captains and those of higher rank, 6s. per day additional.



# Digest of Wireless Literature

## HETERODYNE RECEPTION.

It is a well-known fact that for receiving continuous waves two methods can be employed: either the incoming oscillations are split into groups (by means of some kind of interrupter—*e.g.*, a tikker), or they are made to combine with oscillations of a slightly different frequency which are usually generated at the receiving station. If the latter method (known as the heterodyne method of reception) is employed, beats are obtained, the frequency of which (given by the difference in the frequencies of the incoming and locally generated oscillations) determines the pitch of the signals. In case of the "chopper" method the pitch depends on the frequency of the interruptions.

Since the heterodyne method involves the infusion of energy from an outside source, we would naturally expect that the incoming signals will not only be rendered audible owing to the beats, but that they will also be amplified. This *a priori* expectation is confirmed by the results obtained in practice.

The question arises now as to the degree of amplification which can be obtained by this method. The answers given so far to this question are very contradictory. While Dr. Cohen asserts that he was able to obtain amplifications up to a hundred and more, Dr. Liebowitz, on the other hand, entertains the opinion that the maximum amplification cannot exceed 4. The present article is an attempt to throw some light on this question.

The author shows that the degree of amplification which may be expected from the application of the heterodyne will depend on the nature of the detector employed. In the case of a crystal detector two assumptions as to its rectifying action can be made.

According to one, we consider the crystal as a thermo-junction which is heated by the current due to the received signals. This would lead to the generation of an E.M.F. proportional to the square of the heating current.

According to the second assumption the detector is considered to possess a definite resistance for currents flowing in one direction and a very great or, in the ideal case, an infinite resistance in the opposite direction. Taking now the case of a pure heterodyne arrangement as shown in Fig. 1, where *D* is the crystal detector, *T* the telephone and *G* the local source of H.F. currents, the author discusses first the question of amplification on the former assumption.

Since the received and the local oscillations differ slightly in frequency, there will be a variable difference in phase between the two currents, the limits of variation being 0 and 180°. The resultant of the combined oscillation is shown in Fig. 2*a*. The variable amplitude will attain its maximum at the moment when the currents coincide in phase and its minimum when they oppose each other. Denoting the received current by

$$i_1 = I_1 \sin \omega_1 t$$

and the locally generated current by

$$i_2 = I_2 \sin \omega_2 t,$$

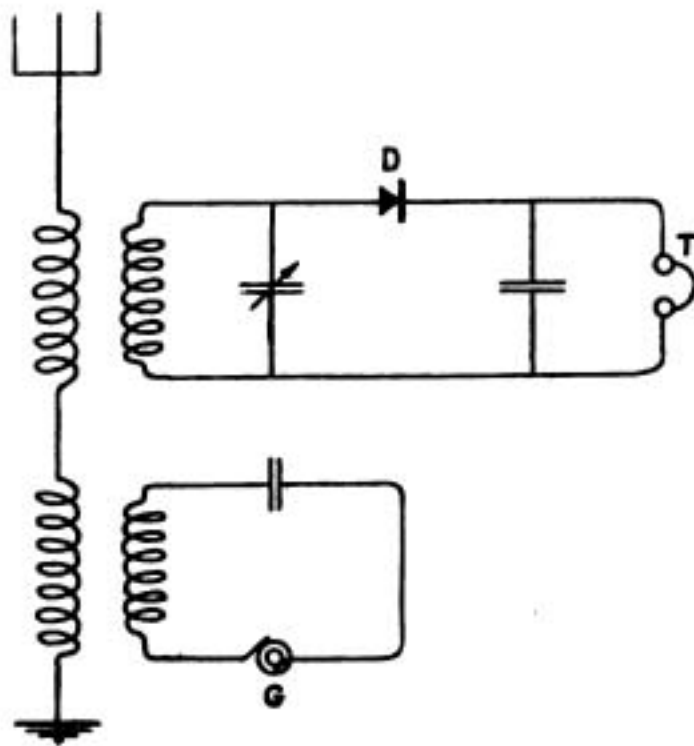

FIG. 1.

we shall see that the amplitude of the combined oscillation will vary between

$$I_1 + I_2 \text{ and } I_2 - I_1.$$

On our assumption, the amplitude of the current in the telephone will vary between

$$0.5k (I_1 + I_2)^2 \text{ and } 0.5k (I_2 - I_1)^2,$$

where  $k$  is a constant depending on the nature of the detector and the impedance of the telephone. (The factor 0.5 is the well-known ratio of the mean value of the squares of the instantaneous values and the square of the amplitude.)

The curve of the telephone current is shown on Fig. 2*b*, and it will be seen that it is equivalent to a steady current on which is superimposed an A.C. with an amplitude given by,

$$\frac{1}{2} [0.5k (I_1 + I_2)^2 - 0.5k (I_2 - I_1)^2] = kI_1 I_2 \quad \dots \quad (1)$$

If heterodyne is not employed we have to interrupt the oscillations at some audible frequency, and we obtain a graph like the one shown on Fig. 3*a*, where the duration of the open and closed periods is assumed to be the same. The telephone current will then be represented by the graph shown on Fig. 3*b*. This can be considered as an A.C. curve of a rectangular shape and with an amplitude

$$\frac{1}{2} \times 0.5 \cdot kI_1^2 = \frac{1}{4} kI_1^2.$$

Our curve can be analysed by the usual methods into a fundamental sine wave, which determines the pitch of the note, and harmonics, on which the character of the note will depend. The amplitude of the fundamental wave is obtained from the amplitude of the rectangular wave by multiplying the latter with  $\frac{4}{\pi}$ . Therefore for our case, we shall have :

$$\frac{1}{4} kI_1^2 \times \frac{4}{\pi} = \frac{kI_1^2}{\pi}.$$

Assuming that the sounds produced by two currents can be compared by the comparison of their fundamental waves, we obtain :

$$\frac{\text{Telephone current with heterodyne}}{\text{Telephone current without heterodyne}} = \frac{kI_1 I_2}{k \frac{I_1^2}{\pi}} = \pi \frac{I_2}{I_1} \quad \dots \quad (2)$$

Next, the ratio of amplification is worked out on the second assumption made above with respect to the detector.

With an absolutely rectifying detector we shall obviously have a curve similar to the one shown on Fig. 2*a*, with this difference, however, that the lower part will be chopped off (Fig. 4*a*). The amplitude will vary again between

$$I_1 + I_2 \text{ and } I_2 - I_1.$$

The mean values of the current will vary between

$$\frac{2}{\pi} (I_1 + I_2) \text{ and } \frac{2}{\pi} (I_2 - I_1).$$



Taking into account that the current flows only during half the time, we obtain a variation between

$$\frac{I_1 + I_2}{\pi} \text{ and } \frac{I_2 - I_1}{\pi}$$

The mean value of amplitude of the audio current will then be given by:

$$\frac{1}{2} \times \left[ \frac{I_1 + I_2}{\pi} - \frac{I_2 - I_1}{\pi} \right] = \frac{I_1}{\pi} \quad (3)$$

Assuming that the curve which can be thus obtained is approximately a sine curve,\* we may consider the last expression as giving a measure of the audio current when heterodyne is applied.

Without heterodyne we would obtain the graph shown on Fig. 4b. Reasoning in the same way as above, we shall find that the amplitude of the rectangular curve is given by

$$\frac{1}{2} \times \frac{1}{2} \times \frac{2 I_1}{\pi} = \frac{I_1}{2 \pi}$$

The amplitude of the fundamental sine wave will then be given by

$$\frac{4}{\pi} \times \frac{I_1}{2 \pi} = \frac{2 I_1}{\pi^2}$$

We obtain

$$\frac{\text{Telephone current with heterodyne}}{\text{Telephone current without heterodyne}} = \frac{I_1/\pi}{2 I_1/\pi^2} = \frac{\pi}{2} \quad (4)$$

Since the audio power is proportional to the square of the telephone current, we shall have:

1. Assuming that the telephone current is proportional to the square of the radio-current:

Amplification of audio power due to heterodyne

$$A_1 = \pi^2 \left( \frac{I_2}{I_1} \right)^2$$

$A_1$  will grow indefinitely with the increase of the amplitude of the locally generated current ( $I_2$ ).

2. Assuming that the audio current is proportional linearly to the radio current, we obtain:

$$A_2 = \frac{\pi^2}{4} = 2.5 \text{ (very roughly).}$$

The amplification due to

\* The author does not make this assumption. He works out the exact equation of the curve and analyses it into a fundamental and harmonics.

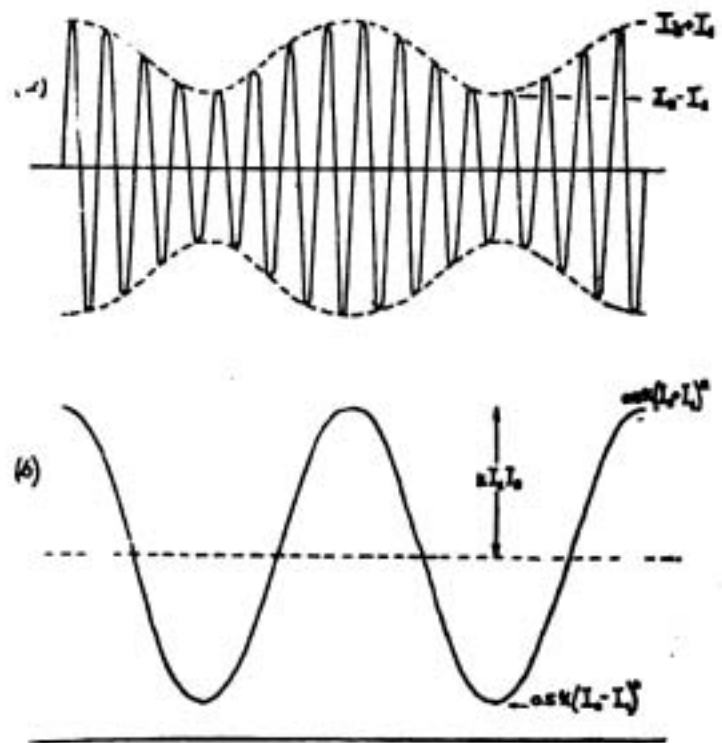

FIG. 2.



FIG. 3.

heterodyne is practically\* independent of the amplitude of the locally generated current.

In the last section of the article the author discusses the question of the increase in the efficiency of the detector which is due to the heterodyne. He arrives at the conclusion that the importance ascribed to this factor by Dr. Liebovitz is not warranted.

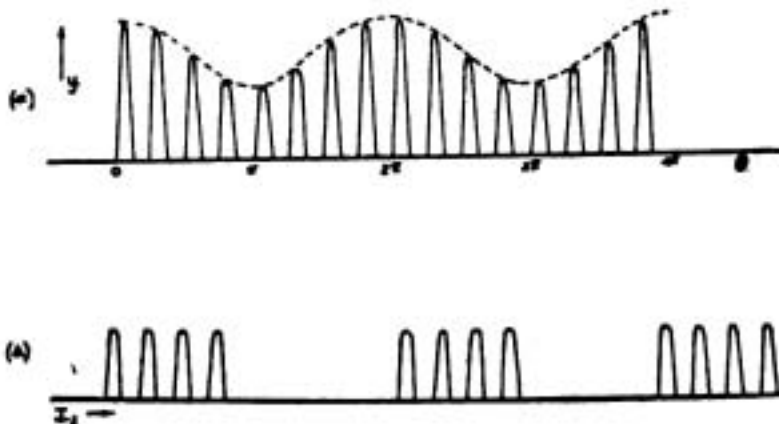

FIG. 4.

joining a metal filament lamp in series with the instrument. This has the effect of opening out the lower part of the scale.

For low readings the cold resistance of the lamp is in series with the voltmeter, whilst for high readings the value of this resistance is increased by the rise in temperature. This has the effect of giving larger deflections for the former than for the latter.

By comparison of Curves I and II, Fig. 5, it will be seen that when the lamp is in use the deflection obtained for, say, 20 volts increases from 5 to 15 degrees, whilst for 220 volts the deflection is the same as when the ordinary series resistance is used. At the lower end of the scale, from 0-20 volts, the deflection is about  $\cdot 75^\circ$  per volt. At the upper end the deflections are only about  $\cdot 4^\circ$  per volt.

Errors which might be expected to arise from changes in the filament and vacuum are unimportant when a high degree of accuracy is not required.

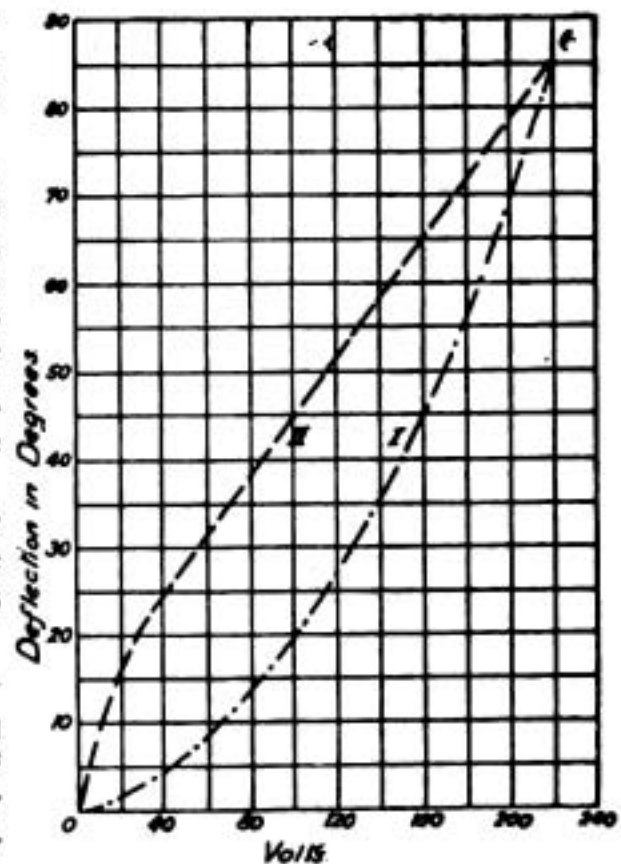

FIG. 5.

\* For the reason of this qualification see the original paper, where the author shows that the amplification *does* depend on  $\frac{I_2}{I_1}$ , but in such a way that  $A_s$  grows very slowly with the increase of this ratio and tends to a limit given by  $\frac{\pi}{2}$ .

## A New Japanese Station

A LARGE wireless station is to be erected by our Japanese allies in the Prefecture of Fukushima at a cost approaching £100,000. The transmitting station will be at Hibarigahara, near Hara-Machi, and the receiving station at Hosoyacho. The new station will be in operation in two years and will communicate directly with San Francisco, a distance of roughly 4,600 miles. We wonder how many repetitions will be asked for by the San Francisco operator when he is first given the name of the transmitting station.



# The Amateur Position

## *A Plea for the Removal of Restrictions.*

*"I consider that the existence of a body of independent and often enthusiastic amateurs constitutes a valuable asset towards the further development of wireless telegraphy."*—SENATORE MARCONI.

ON August 3rd, 1914, as a measure of safety, His Majesty's Government called for the immediate closing of all amateur wireless stations throughout the Kingdom. A little later all amateur apparatus was sealed up, and in the great majority of cases removed by Post Office officials for safe keeping. After a further short period a prohibition was even placed upon the publication of articles which could in any way be looked upon as encouraging the manufacture of amateur apparatus, and so, throughout the whole of the terrible world conflict, practical amateur work has been completely suppressed.

More than three months have now passed since the signature of the Armistice and still no word comes from the Government of their intentions in regard to the wireless amateur. Indeed, many people have the notion that the authorities, once having taken complete control of wireless communication, will relinquish their hold very reluctantly, and in their future activities may totally prohibit the erection and the maintenance of a wireless installation by the amateur.

Now, although the Government may have no such intention—in any case we sincerely *hope* that they have no such intention—it is fitting that we should consider the whole position of the amateur in his relation to the future of wireless telegraphy.

First of all we must bear clearly in mind that the amateur wireless movement has proved of inestimable value to the country by providing a large body of enthusiastic wireless men who have willingly and eagerly stepped into the breach to fill the need for Army, Navy, Air Force and Mercantile Marine operators. No matter where we may turn in the wireless branches of these four services we shall find numerous officers and men who gained their first knowledge of the subject through their amateur activities and private installations. These men, having given so much to their country, will regard it as their right to resume their hobby on demobilisation and on the return of peace conditions. It will not be sufficient for the Government to allow experimental work by technical institutions and schools—this alone will not be giving freedom to the experimenter. The wireless amateur has earned the right to demand that he shall be reinstated on conditions which will allow him complete freedom to carry out the work which he has so much at heart.

Of the arguments which will undoubtedly be brought forward by those who may seek to repress the amateur movement one of the first will be that of "interference." This matter has been discussed at length on many occasions. The point is covered by the broad statement that what little interference existed in the past from amateur stations was caused by improper adjustment of receivers and transmitters and poor operation. It should be quite easy to provide regulations to prevent interference without in any way hindering the genuine amateur from

carrying out his work. A further argument will be that of lack of secrecy. To this we may answer that it is impossible to ensure entire secrecy in *any* field of communication. All wireless messages in transmission are not easily available to any who care to listen, and it is wholly unfair to the art of wireless telegraphy to foster this opinion in the public mind. The true situation is that the telephone, telegraph, cable and wireless circuits can all be tapped by those who *deliberately set out to do so*. If amateurs are not allowed to carry out their work, does the country gain any assurance that secrecy is thereby guaranteed? Deliberate spying can be carried out equally well whether such restrictions exist or not.

The amateur is not typified, as many would like the public to believe, by an irresponsible boy tinkering with "tin-can" apparatus in a back yard. As a class the amateur is better represented by a number of commissioned and non-commissioned Army, Navy and Air Force officers and men called to the colours from civilian pursuits, and engaged throughout the field of battle in wireless work of vital importance.

In our endeavour to make the position quite clear to the public we have approached no less an authority than Senatore Marconi himself, who expresses his views on the subject below. Furthermore, Dr. J. A. Fleming and Dr. W. H. Eccles—both scientists of the first rank—have kindly given us the benefit of their views.

In the United States a Bill was recently introduced with the object of giving the Government the complete monopoly of wireless communication and repressing the amateur entirely. Such a storm of protest was raised by this arbitrary move and such a volume of powerful argument was adduced that the project failed, with the result that the American amateur will be reinstated on conditions closely resembling those under which he worked in pre-war days. We trust to the good sense of the fair-minded British public to see that justice is done in this country as well.

#### SENATORE MARCONI'S VIEWS.

*The following letter, addressed to the Editor of THE WIRELESS WORLD, has been received from Senatore Marconi, G.C.V.O., LL.D., D.Sc., etc.*

DEAR SIR,—In response to your request that I should express my views with regard to the proposed legislation to prevent amateurs experimenting with wireless telegraphy, I wish to state that, in my opinion, to follow such a course would be a mistaken policy.



SENATORE G. MARCONI.

It should be borne in mind that in many or, perhaps, in all branches of radiotelegraphy finality has by no means been reached, and I consider that the existence of a body of independent and often enthusiastic amateurs constitutes a valuable asset towards the further development of wireless telegraphy. It is wise also to remember that had it not been for amateurs wireless telegraphy as a great world-fact might not have existed at all. In the United States, for example, a great deal of the development and progress of wireless telegraphy is due to the efforts of amateurs.

I think, therefore, that the suppression of the work of those amateurs who are interested in wireless telegraphy would be against the public interest.

I am quite aware that public service must be the first consideration, especially in view of one of the chief advantages of wireless telegraphy—viz., its power of radiating outwards from any and every centre. I feel convinced, however, that by the enactment of proper safeguards and by the adoption of suitable and improved



devices, many of which already exist, for preventing interference with public services, any dangers arising from the efforts of amateurs would be practically eliminated.

(Signed) G. MARCONI.

#### DR. J. A. FLEMING'S PLEA FOR THE AMATEUR.

*Dr. J. A. Fleming, M.A., F.R.S., Professor of Electrical Engineering in the University of London, etc., has been associated with wireless telegraphy, as our readers know, from the earliest days of the science. He says :*

*To the Editor of THE WIRELESS WORLD.*

SIR,—Now that the war is happily ended we ought as soon as possible to be freed from certain shackles of bureaucratic control and from any restrictions which were essential for national safety during the progress of the struggle. One of these is the permission under licence to conduct research in radiotelegraphy and telephony. At the outbreak of the war all private and University radio stations were dismantled and non-official research stopped. The question then arises—how soon will these restrictions be removed? It is a matter of common knowledge that a large part of the important inventions in connection with wireless telegraphy have been the result of amateur work and private research, and not the outcome of official brains or the handiwork of military or naval men. In fact we may say that wireless telegraphy itself in its inception was an amateur product. At the time when Senatore Marconi first made known his epoch-making inventions the official telegraphists of the General Post Office had been working for years and spending large sums of public money in trying to develop and exploit the magnetic-induction and earth-conduction methods of wireless telegraphy of very limited application, but, apart from certain pioneer work by Admiral Sir Henry Jackson, they did not succeed in utilising electro-magnetic waves for this purpose until Mr. Marconi showed them how to do it.



DR. J. A. FLEMING.

Then, again, numerous important inventions such as the crystal detectors, the oscillation valve, the three-electrode valve, the electric arc generator, the high-frequency alternator-directive radiotelegraphy beat reception, all the important uses of the thermionic detector, and much work on the study of atmospheric stray waves, has been due to private or amateur expert work, and not to official electricians in the General Post Office or the Army or Navy. If, then, full opportunities for such non-official work and research are not soon restored there is no question that the progress of the art of radiotelegraphy and telephony will be greatly hindered.

In an article published by me just eighteen years ago in *The Nineteenth Century and After* (February, 1901) entitled "Official Obstruction of Electrical Progress," I pointed out how much of all electrical discovery and invention has been due to amateur work, including in that term teachers and private investigators of all kinds.

The action of Government officials has been in most cases to hinder and not help progress. As a rule the most effective method of afflicting any department of applied science with lethargy is to constitute it a Government monopoly. The past history of telephony in this country is a striking example of the truth of the above statement. A strong effort ought therefore to be made to maintain the opportunities, under proper regulations, of private research in radiotelegraphy. If all such independent work is to be throttled by the maintenance of present inhibitions

it is unquestionable that progress will be hindered and that inventions of great utility may never see the light.

I venture, therefore, to suggest that those interested in the scientific advance of radiotelegraphy should make their views and influence felt in preventing the entire extinction of private research work in radiotelegraphy. We do not want every schoolboy to be jogging up the æther or picking up every passing message, but we do ask that those unofficial investigators who have power to enlarge the boundaries of our knowledge shall not be locked out from an arena in which great possibilities of discovery still exist.

The fact that the British Association appointed, at my suggestion, a committee on Radiotelegraphic Research presupposes the opportunities for such work, and we do not wish to see all possibilities of it entirely destroyed.

I am, sir, etc.,

(Signed) J. A. FLEMING.

University College, London,  
February, 1919.

#### PROFESSOR ECCLES'S VIEWS.

*Professor W. H. Eccles, D.Sc., A.R.C.S., M.I.E.E., Professor of Applied Physics and Electrical Engineering at the City and Guilds of London Technical College, Finsbury, Honorary Secretary of the Physical Society, Honorary Secretary of the British Association Committee for Radiotelegraphic Investigation, etc., writes as follows:*

DEAR SIR,—In response to your invitation to send you an expression of my views on the possible promotion of legislation for the limitation of experiments in wireless telegraphy, I give below what seem to me to be the main considerations bearing on the matter.



PR. W. H. ECCLES.

The paramount factor must be, of course, that of the national interest, and this has broadly two aspects. On the one hand, this new and increasingly important means of communication must be put into a position to render immediately the greatest possible public service in the affairs of peace and war; and on the other hand, improvements and invention must be stimulated to the utmost, not only for their own sake, but also in order that this country may take a high place among the nations of the world in radio-telegraphic manufactures.

There is in some degree a conflict between these two aspects, a conflict that arises out of one of the chief virtues of wireless telegraphy—namely, its broadcast character. The waves of experimental sending stations may disturb service stations while they are in the act of receiving their messages, and thus a few inconsiderate experimenters may greatly reduce the value of the most perfectly organised public service. The obvious and hasty solution of the difficulty is to limit experimental stations to a small number by law and control experiments and experimenters by the rules and regulations of a Government Department. But this simple solution would probably have as its main result the hindering of research—which is the father of invention—and the slowing down of progress in this country. This is certainly not to the national interest.

Perhaps it will be urged that research and experiment could be put into the hands of State Laboratories, and permitted to a selected few firms and persons. It is possible that such a policy might be successful for a time, but as it would doubtless have the effect of reducing the number of students of wireless telegraphy



it would ultimately deflect ability away from this subject, and conceivably deprive wireless telegraphy of the genius that might have enriched the technology and the nation under wiser legislation.

It is unfortunate that in the simplest methods of beat reception the receiving antenna radiates while in the act of receiving; but this can be remedied by, for instance, connecting the antenna to the local oscillating circuit through a three-electrode thermionic tube, which acts as a trap and allows oscillations to pass inwards from the grid circuit to the plate circuit, and not outwards. This and other devices for the same purpose would soon be perfected, and in operation if the law were focussed mainly upon the prevention of interference.

In conclusion, I think it is not impossible to devise laws to impose such restrictions upon the emission of waves as will preclude interference with the public radio service of the future, and yet allow of liberal opportunity for the experimental study of wireless telegraphy.

Yours faithfully,  
(Signed) W. ECCLES.

#### A CALL FOR OUR READERS' VIEWS.

We shall deal in future articles with the amateur position as it develops, and meanwhile we place our columns freely at the disposal of our readers for the expression of their views. All communications on this subject should be addressed to the Editor of THE WIRELESS WORLD.

#### NORTH MIDDLESEX WIRELESS CLUB.

Will former members and prospective members of this Club please communicate with the Hon. Sec., E. M. Savage, Nithsdale, Eversley Park Road, Winchmore Hill, N.21?

## Communication with the Stars

### *Some Interesting Speculations*

COMMUNICATION with the stars is an ever fruitful source of speculation, and for this, among other reasons, considerable interest was aroused by the interview with Senatore Marconi, published in the *Daily Chronicle* recently. The interviewer, Mr. Harold Begbie, asked the famous scientist whether he thought as some do, that the waves of ether are eternal. He replied:—"Yes, I do. The messages I sent off 10 years ago have not yet reached some of the nearest stars. When they arrive there, why should they stop? It is like the attempt to express one-third as a decimal fraction; you can go on for ever without coming to any sign of an end. That's what makes me hope for a very big thing in the future."

Senatore Marconi then went on to state that he hoped for communication with intelligence on other stars. Dealing with the question of the language difficulty, he said that although it was an obstacle he did not think it was insurmountable. "You see, one might get through some such message as 2 plus 2 equals 4, and go on repeating it until an answer came back signifying yes—which would be one word. Mathematics must be the same throughout the physical universe. By sticking to mathematics over a number of years, one might come to speech; it's certainly possible."

Certainly communication with the stars, if at all possible, must be effected by wireless telegraphy, and the more recent discovery of a means of magnifying signals to almost any degree places within our hands an instrument of almost infinite delicacy. When so great a scientist as Senatore Marconi talks seriously of these possibilities it behoves the sceptic to consider his position.

# German Wireless in Metz

## *Particulars of a Captured Enemy Installation*

FORTY-NINE years ago—in August 1870 to be precise—the French under Bazaine were compelled to retire into the fortress of Metz after a vain endeavour to beat off the enemy hordes. The siege which then commenced was of long duration, ending, as all the world knows, in the yielding up of the great fortress to the Germans. Thenceforward, and until the Armistice was signed in November last, Germany remained in occupation, ever increasing the strength of this wonderful circle of forts, and jealously guarding its secrets.

For a long time it had been known to the army of the Allies that a powerful wireless station was in existence in Metz, and one of the first steps taken by the French authorities on re-entry was to photograph the installation throughout. Thanks to the excellent French official news service, we are able to give this month a set of photographs which clearly indicate the chief characteristics of the station.

Our readers will see that the whole station buildings are below the level of the ground, a good general view of the situation being given below. Whilst this sunken position may afford a certain amount of protection, the existence of the station may be perceived at a distance from the masts and aerial fittings. Furthermore, we doubt whether the thickness of concrete shown in our second illustration would be sufficient protection from a modern high-power bomb, while curiously enough the sides of the station in the trench seem particularly vulnerable.

The aerial system is held aloft on two main masts and a number of shorter poles. One of these masts, as shown on page 675, is of the well-known Rendahl

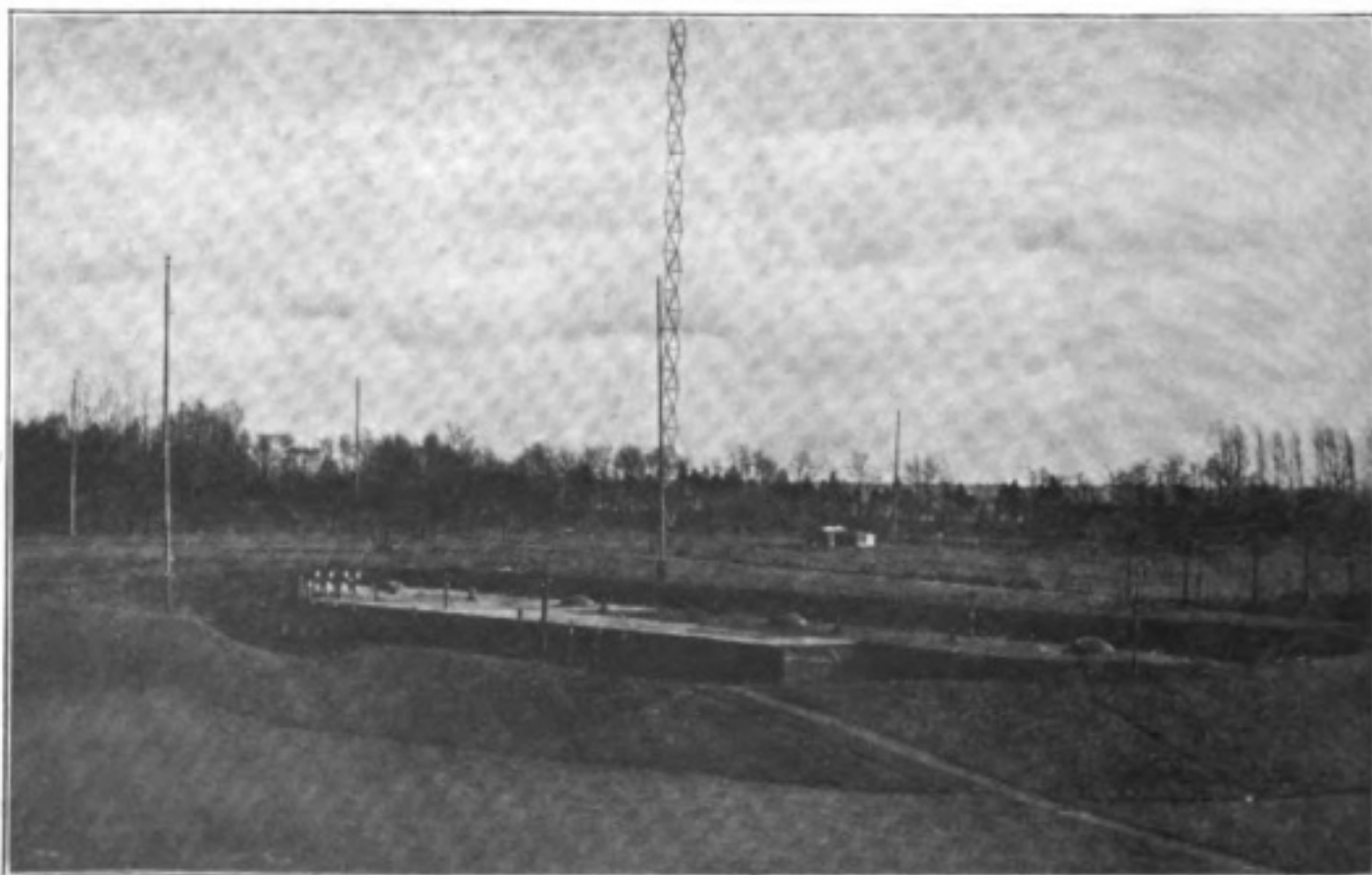

[Photo: French Official.]

GERMAN WIRELESS STATION AT METZ: A GENERAL VIEW.

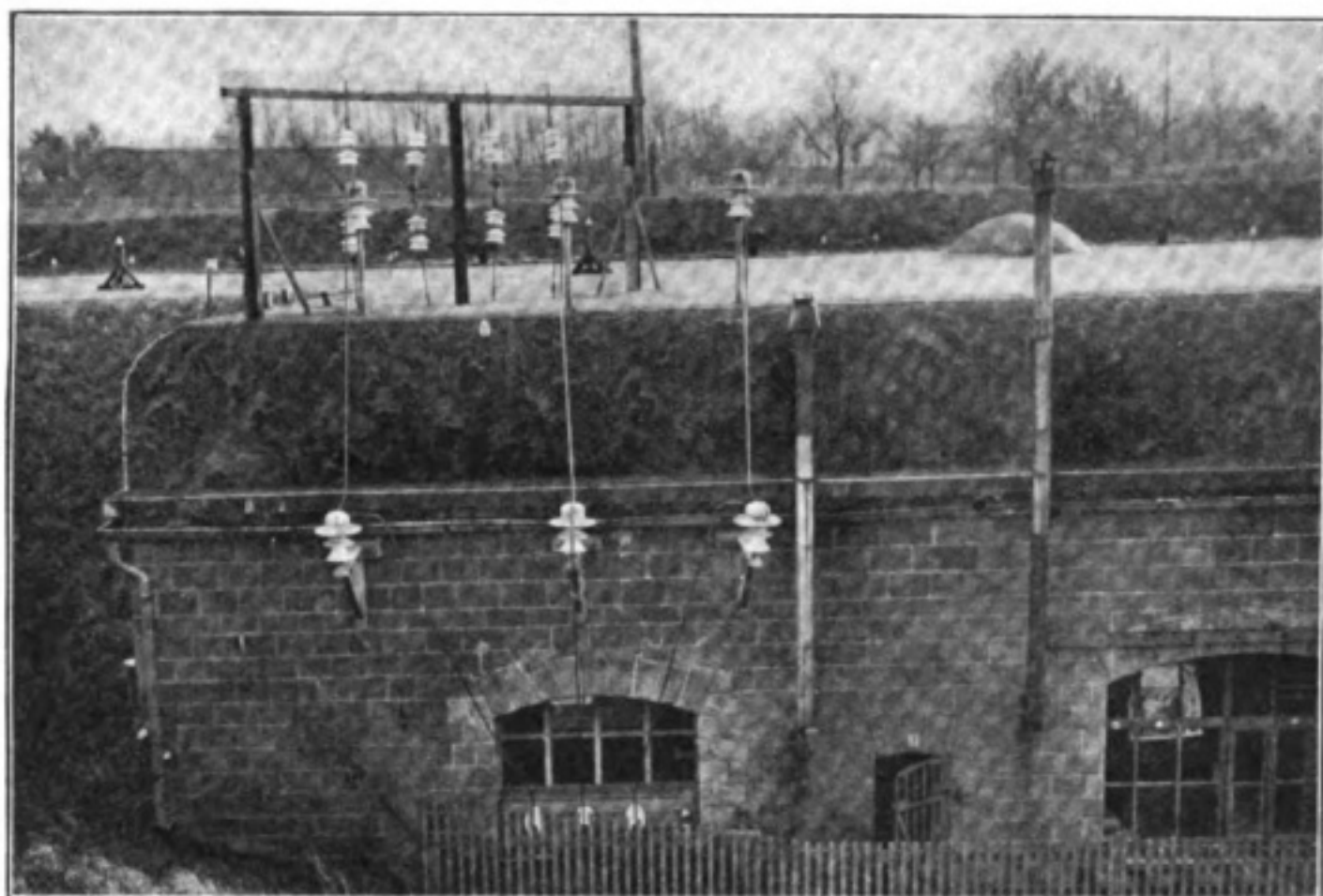

THE AERIAL LEAD IN AT METZ STATION.

[French Official Photo

type, constructed of metallic tubes bolted together, the whole being of triangular shape and resting upon an insulated base. This type of mast, while being particularly light and strong, has the great defect that the breakage of any individual tube may bring about the immediate collapse of the whole structure. In this way a flying piece of shrapnel might bring the whole aerial system to the ground. A further peculiarity of these masts lies in the fact that the metalwork forms part of the aerial. A second mast, entirely of wood, is of the same height as the Rendahl mast—*i.e.*, 250 feet.

The aerial, as will be observed from the photograph on this page, is led into the station by three down leads supported by heavy porcelain insulators. The interior of the station seems to be quite roomy, and contains several sets of apparatus, with arrangements for transmitting and receiving both damped and continuous waves on a number of wave-lengths. The damped wave transmitter, which we have not illustrated here, possesses no point of novelty, being a standard Telefunken quenched gap installation of moderate power. The continuous wave transmitter, illustrated on page 674, is a high-power Poulsen arc, evidently manufactured by the well-known firm of C. Lorentz. Although at first glance this arc transmitter would seem to be extremely complex, closer examination reveals the fact that much of the complexity is due to wiring and auxiliary apparatus. If we examine the arc apparatus itself, we shall see that the separation of the magnet poles can be varied by means of large insulation discs, one of which can be seen at the left-hand end of the arc table. The powerful magnet windings are sectionally wound, and fit on to the magnet pole pieces, being wired in such a way that the strength of the field can be altered at will. This is necessary, as it has been found that there is a best strength of field for each particular wave-length. Connections from the various separate windings can be seen projecting along the top of the apparatus, and leads are taken to a switching device not shown. The carbon pole of the arc is slowly rotated by means of the electric motor to the left of, and just below, the insulating disc in the

B



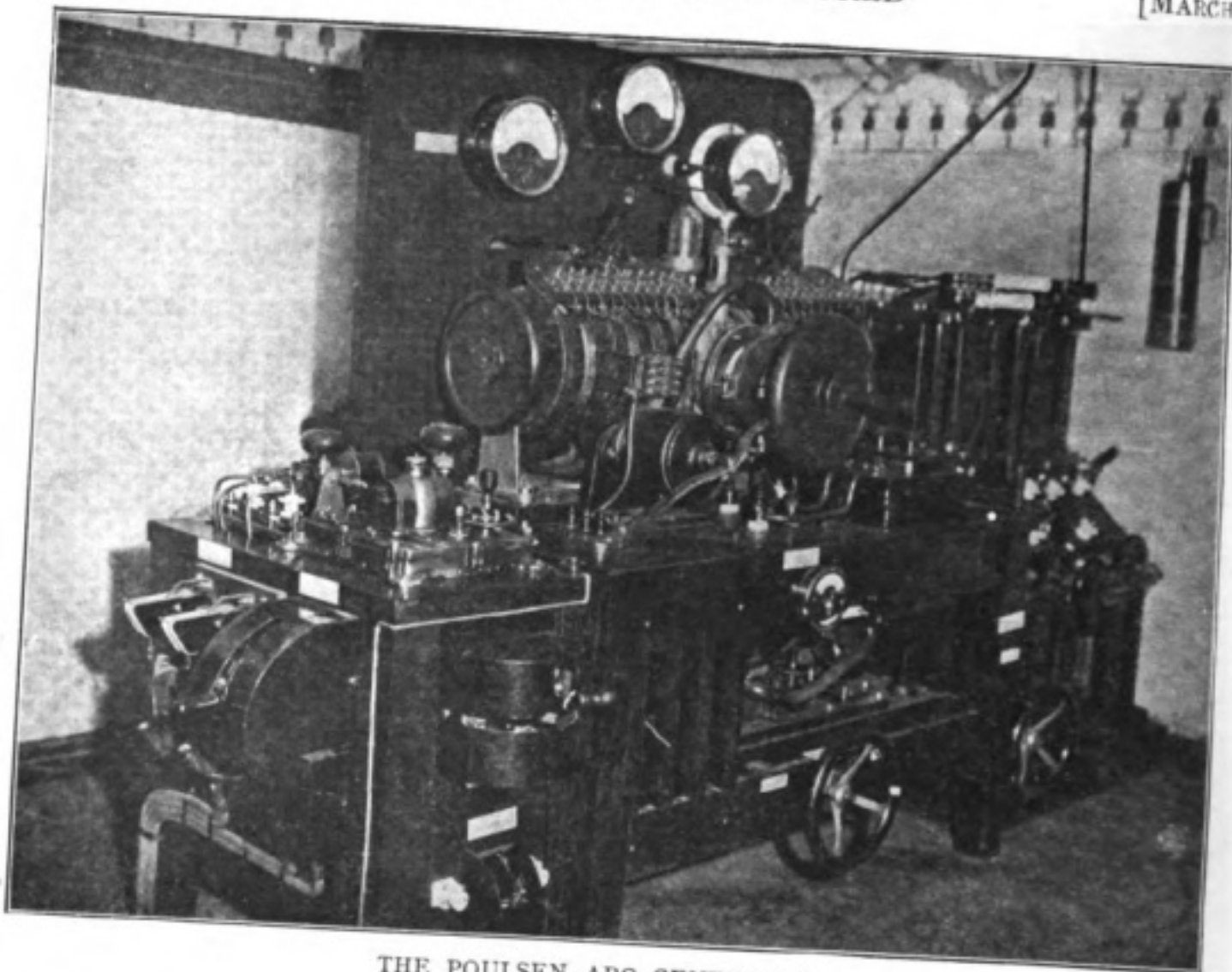

THE POULSEN ARC GENERATOR.

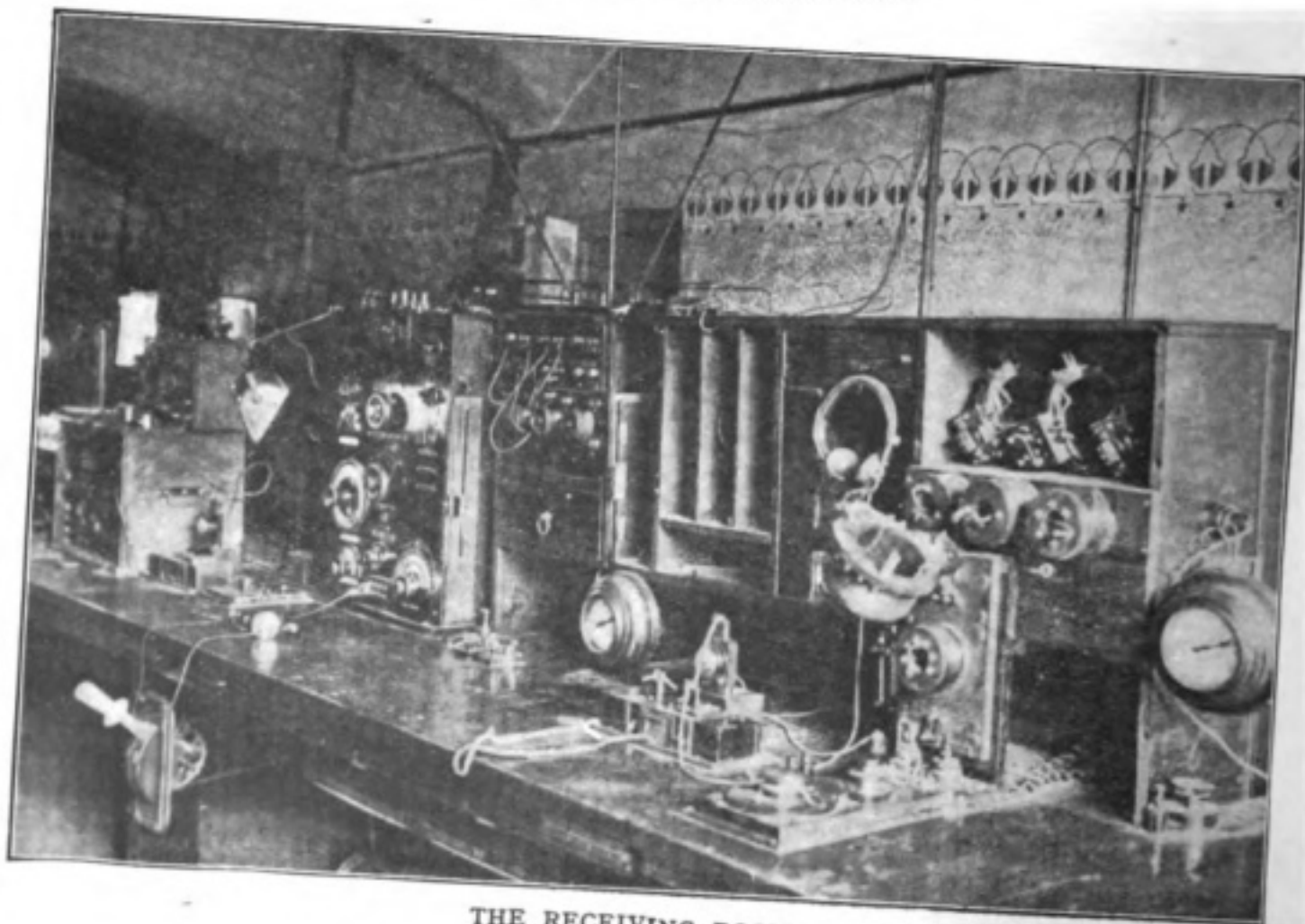

THE RECEIVING ROOM.

[Photos : French Official.

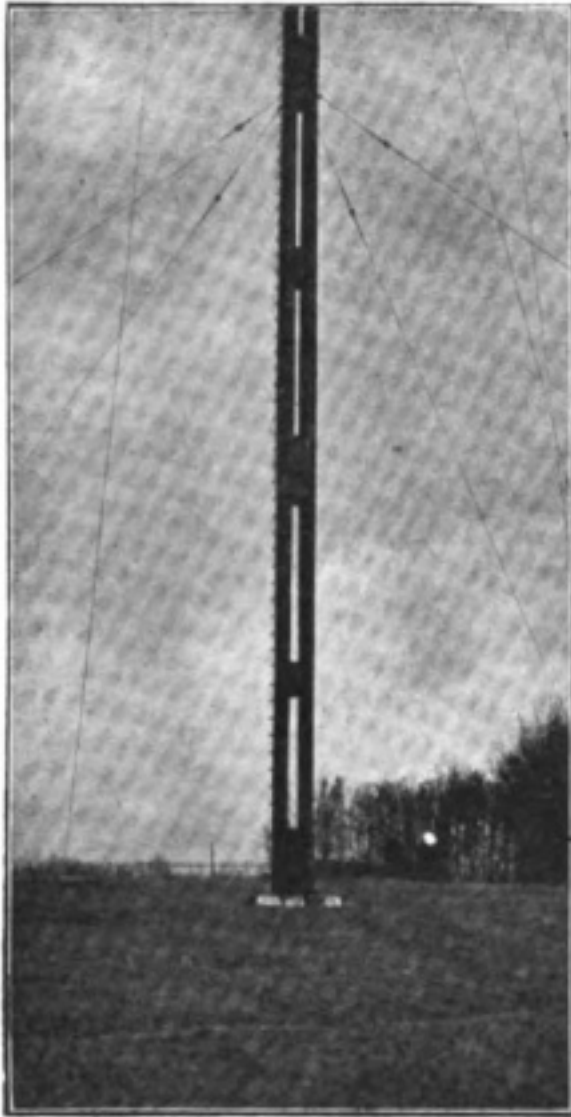

*LEFRONCH Ufficial*

A WOODEN MAST, 250  
FEET IN HEIGHT

receiving rooms. In the transmitting room this frieze consists of conventionalised insulators, as will be seen from the photograph of the arc apparatus. In the receiving room telephone headpieces take the place of the insulators, and perhaps form a more artistic pattern! This laborious ornamentation may be taken as typical of the German mind; certainly British operators would find something much more useful to do.

In the receiving room accommodation is provided for the reception of a wide range of wave-lengths by several operators. The lower photograph on page 674 shows the general arrangement of the main receiving table, a particular feature being the orderly pigeon holes for apparatus and papers. On the right will be seen sunk in the table a standard Telefunken receiver with a number of additional primaries and secondaries conveniently to hand. In the centre of the table a receiver of different type is fitted, utilising valves for reception.

centre of the arc apparatus. The necessary hydro-carbon atmosphere is provided by vapour of alcohol, which drips into the arc chamber from a source above.

The copper electrode is water-cooled, and one of the circulating pipes can be seen in the centre of the apparatus and also below the table. At the back of the arc will be noticed a switchboard with three indicating instruments, the two on the left being presumably an ammeter and a voltmeter respectively, while that on the right, seeing that it is mounted on a special base, is probably an aerial ammeter. The two wheels below the table operate the wave-changing device or some similar adjustment, while the table on the left of the arc, with the large switch handles, contains the transmitting relays which are operated from the manipulating key. German caution in handling this apparatus is exemplified by the fire extinguisher hanging within easy reach.

A curious feature of this station, and one which has been found in several others captured

from the enemy, is evidenced in the stencilled frieze around the walls of both transmitting and



*LEFRONCH Ufficial*

A TRIANGULAR STEEL MAST.

B2



# Notes of the Month

## AIRSHIP WIRELESS.

ONE of the most dramatic stories of the use of wireless in aircraft is provided by the account of the sensational Zeppelin voyage from Jamboli, in Bulgaria, 55 miles north of Adrianople, towards German East Africa and thence back to the starting point. The distance covered was 4,560 miles, not 8,000 miles as first reported, and the whole voyage was accomplished in 96 hours. The white German troops, in the autumn of 1917, were being decimated by malaria, and General von Lettow had sent word by wireless that unless a supply of quinine reached him by a certain date he would be unable to carry on. The Zeppelin airship, L59, in charge of Captain von Butlar, was therefore despatched on her long journey. Leaving in the early hours of the morning of November 21st, 1917, the airship made her way south and 46 hours later was steering towards Khartoum at a height of 5,000 ft. At this point a wireless report from Nauen was received, saying:—"Return. East Africa occupied." As a consequence the vessel returned to Jamboli, having broken all records in long distance flying. This voyage, besides being remarkable from the scientific point of view, reveals the enormous strides which have been made in aircraft wireless to enable this message to be received from such a great distance.

## A PRISONER'S HANDIWORK.

Among the interesting exhibits at the Ruhleben Exhibition in the Central Hall, Westminster, is a beautiful model of the oil tank, *San Wilfrido*, made by the wireless operator, Mr. Ben Baxter, during the trying hours of his captivity. The *San Wilfrido* was one of the first vessels to be taken by the Germans and, as a matter of fact, was seized the day before we went to war. Mr. Baxter was one of the repatriated prisoners who returned to this country through Holland a few months before the Armistice was signed.

## ENGLISH APPARATUS SUPERIOR.

According to the *Daily Mail*, an American engineer from the Western Electric Company recently visited England to investigate the wireless telephones of the Royal Air Force, and to make comparative tests with American instruments. He declared that the British wireless telephones are far in advance of those in use in the American Air Force. Pilots can speak to their Ground Commanders and to one another at a distance of 15 miles, and the only difficulty in communicating between machines and the ground at greater distances is the consideration of the weight of larger instruments. Between airships, for instance, it is possible to carry on a conversation at a distance of 50 miles. We were very glad to observe the publication of this statement, as the lay press has given so much publicity to the extravagant claims of American inventors. It is also a disguised tribute to the Marconi Company, who were the first in England to evolve a wireless telephone, utilising an oscillating valve as the source of the high-frequency current. This occurred some time before the war, and since the outbreak of hostilities they have contributed enormously to the progress in this art.



## CANTOR LECTURES.

On February 10th, at the Royal Society of Arts, Dr. J. A. Fleming delivered the first of three lectures on the subject of "The Scientific Problems of Electric Wave Telegraphy."

Commencing with a brief but luminous explanation of wave-motion, Dr. Fleming then considered several of the most notable theories of the ether, with special reference to its properties, and gave an account of Maxwell's Electromagnetic Theory of light, rendering the latter especially interesting by showing how Maxwell's fundamental equations are arrived at. Next were discussed Hertzian waves, their production and properties, while the interlinking of the electric and magnetic components of these waves was brought out strongly and clearly.

The latter portion of the lecture was devoted to the methods of creating electromagnetic waves, and included a description of the Goldschmidt frequency changer and the Alexanderson machine for generating H.F. alternating current. In speaking of the latter machine, Dr. Fleming pointed out the extreme accuracy of construction which is demanded, and informed his hearers that in quoting him a price for a 2-K.W. machine of this type the makers asked for £700!

Mr. Marconi's contributions to the art of producing electromagnetic waves by means of discs were also described and illustrated.

The second and third lectures of this series took place on February 17th and 24th, too late for reporting in the present issue.

## WIRELESS IN THE STREETS.

During the course of a paper on "Traffic Control," read at a recent (Operating Department) Efficiency Meeting of the London General Omnibus Co., the lecturer mentioned that he looked forward to the time when wireless connection could be established between the central Control Office and every individual omnibus. However far-fetched this might appear, the audience must remember that such means of communication had been successfully used by the Manhattan (N.Y.) Police Ambulance Station. The scheme was feasible, but the necessity for training large numbers of the staff as Wireless operators would constitute the biggest objection. Wireless telephony, however, does not present such difficulty, or afford unsurmountable "snags." He was not divulging any official secret when he mentioned that he understood the war period had affected huge strides in this branch of wireless science, and that there would be no difficulty in bringing about an installation such as he prophesied.

## THE COMING ECLIPSE.

Dr. Fleming, in a letter to *Nature*, refers to the fact that just before the beginning of the war arrangements had been completed for certain observations to be made on the strength of radiotelegraphic signals on the line of totality of the 1914 solar eclipse which passed through Russia. These arrangements were rendered useless by the outbreak of war. On May 29th of this year a total solar eclipse will be visible in North Brazil, and it seems very desirable, says Dr. Fleming, that any eclipse expeditions sent out to observe it should be provided with wireless telegraph apparatus and should arrange to receive and also to send signals to other stations before, during and after the passage of the moon's shadow.

It is very important to ascertain, if possible, whether there are any effects on signal strength due to the passage of the moon's shadow over a station such as accompany the diurnal passage of the earth's shadow at sunrise and sunset. Evidence obtained from long distance wireless transmission points conclusively to the close connection between it and the ionisation of the upper regions of the atmosphere.

# Valves

By Prof. B. R. OWN, G.R.I.D., T.S.F., &c., and Mr. LETIT LEAK  
(Local Plumber)

## INTRODUCTION.

IN this little article I have tried to set down a few facts and fancies regarding the valve as used in the practice of W/T.

They are the direct result of information collected whilst acting in the capacity of W/T operator in one of Britain's aerial Dreadnoughts, although much of the advanced technical matter is the result of Mr. Letit Leak's untiring research, and to this gentleman I publicly extend my heartfelt thanks for his invaluable assistance in compiling this treatise.

## AUTHOR'S NOTE.

Through long association I had come to look upon the W/T valve as the only valve in the wide, wide world, so vividly were its advantages and merits impressed upon me at Cramwell College. I am assured by Mr. Letit Leak, however, that this is quite a fallacy. He tells me that there are H.P. and L.P. steam valves, gas valves, ball valves, and bivalves, not to mention innumerable others, besides the common or garden dot-and-dash variety.

Valves W/T may be placed in four categories :

- (1) The Round Valve (deriving its name from the inventor, not from its shape).
- (2) The Hard Valve (has slightly longer life than the soft valve when exposed to the tender mercies of the new operator thirsting for knowledge).
- (3) The Soft Valve (so called because it is satisfied with fewer volts than the foregoing instance, and therefore does not require so many ration books).
- (4) The "Q" Valve (better known as the "Hush, Hush" valve—see February issue of THE WIRELESS WORLD for details of results with only seven of these valves. By simple proportion it will readily be seen that 31,967 such valves would receive signals from the planet Jupiter).

All four types are much of a muchness in general principle, differing only in detail.

Taking them collectively, a valve consists of a piece of vacuum surrounded by a layer of glass. A most essential part is the small pip generally found on top of the vacuum. Its precise use has yet to be determined, but Mr. Letit Leak assures me it is a most important *point*. I do not intend to trouble my readers with smaller details, but, in passing, it is imperative to direct attention to a fundamental necessity, which valve manufacturers dare not overlook—viz., the necessity for placing some small parts within the vacuum. These are :

(1) *The Filament*.—A very fragile piece of tungsten made up of  $10^{55}$  negative electrons. Its function is to illuminate the vacuum in order that the student may see how the other parts work.

(2) *The Grid*.—Consists of a number of holes joined together by small pieces of metal. Acts as a shade over filament to protect student's eyes.

(3) *The Sheath*.—A sheet of metal enclosing both the filament and the grid. Prevents small pieces of vacuum, dust, or dirt from falling on the filament and affecting its lighting capabilities.

At the bottom of the valve are a number of tags, generally four, although a few more or less should not worry the student. I was under the impression that these were to form a convenient method of holding the valve without making the glass dirty, but Mr. Letit Leak emphatically insists that these tags exist for the sole purpose of ensuring connection with the internal economy of the valve.



*To Test Valves.*—Carefully examine, and any cracks in glass bulb should be caulked with shellac to prevent the vacuum getting out.

*To Test Filament.*—Grasping the valve by the tags previously referred to, bang the valve several times in rapid succession against the edge of a bench (unless an anvil is handier), when it should give forth a clear, bell-like note. Should the filament fail to glow after this test, don't waste more time with it, but get another from the stores.

*To Test H.T. Circuit.*—Connect up to several thousand volts and forget the exact amount. A faint bluish glow will indicate that the H.T. has successfully run the gauntlet of the vacuum and is looping the loop between the filament and sheath, a process known technically as oscillation. Should no blue glow be detected and the valve and student still survive, throw the valve away—it is a dud.

*To Test Vacuum.*—Knock off small pip mentioned previously, and if vacuum is good a faint hissing noise is heard. When the hissing ceases, it denotes that Nature, which abhors a vacuum, has discovered the escape. It is not advisable to apply this test except as a last resource, owing to the extreme difficulty of re-packing the vacuum through the small hole thus made.

From the foregoing remarks the student must draw his own conclusions as to the advantages of valves. Our W/T Officer says that their tendency to disappear completely and mysteriously is not so marked as that of the carborundum crystal. He attributes this to the post-war amateur not being possessed of sufficient filthy lucre to purchase enough high tension to operate the valve, while the current price of volts is so excessive.

*Finallv.*—Mr. Letit Leak informs me that, owing to the super-sensitive qualities of the valve as a detector, it is probable that Scotland Yard will shortly assume the entire control of the valve industry, and every detective will be fitted with seven valves. Police constables, on the other hand, will only be provided with amplifiers.

For further information read my companion volume, *Detectors for 'Tecs*, price 7s. 6d. in cloth, or 2s. 6d. paper editions.

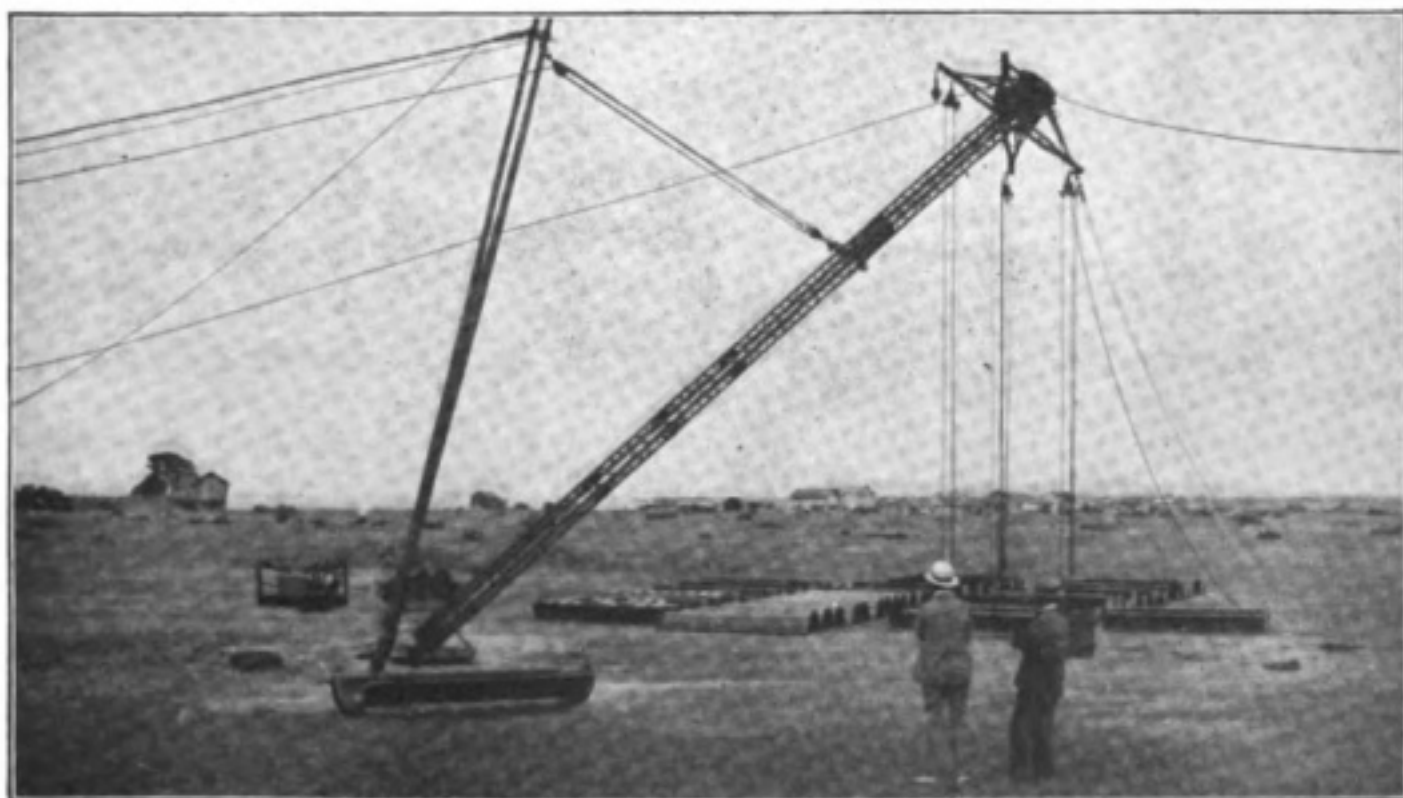

RAISING THE LATTICE TOPMAST AT STA.  
ELENA WIRELESS STATION (SEE PAGE 651).



# Among the Operators

Amongst the many mischances and perils of war the total disappearance of the s.s. "Keltier," of which nothing has been heard since October 1st, 1918, must be mentioned. The operator, Mr. Andrew Craig, of Aberdeen, was born at Portlethen. He was educated at the Victoria Road Public School, afterwards attending Walker Road Continuation School. He gained his First Class P.M.G. Certificate at the Scottish Wireless College, Aberdeen, and joined the service of the Marconi Company on August 16th, 1916.

OPERATOR WALTER HENRY MILLS, who was appointed to the staff of the Marconi Company on April 29th, 1918, has died from influenza and pneumonia. He was resident in London and received his education at private schools in Dover and Penge. For some time he was employed in the engineering department of the Charing Cross, West End and City Electricity Supply Company, and entered the Marconi Company's London school as a learner on October 15th, 1917.

Colleagues who are readers will be sorry to learn of the death from pneumonia of MR. THOMAS DAVISON, late of South Shields. He was landed at Nantes from the s.s. *Cressington Court*, and died on December 29th, 1918. Mr. Davison attended evening classes at the Newcastle School of Wireless Telegraphy and was appointed to the staff of the Marconi Company on January 5th, 1916.

MR. CHARLES PILLING, who died from pneumonia on October 30th, 1918, was born at Farnworth. He was educated at Bolton Grammar School and received wireless training at the Fallowfield College. He was appointed to the operating staff of the Marconi Company on January 17th, 1915, and was attached to the s.s. *Valetta* at the time she was torpedoed.

Another victim of the influenza epidemic was OPERATOR G. L. FLANAGAN, who died on November 5th, 1918. His home was in Leicester, where he was educated at the Holy Cross Schools. He obtained his First Class Certificate at the North British Schools, Edinburgh, and joined the staff of the Marconi Company on June 29th, 1918.

Senior members of the Marconi Company's operating staff will learn with deep regret of the death from influenza and pneumonia of OPERATOR MARTIN ROHAN, who was appointed to the staff on August 2nd, 1914. Mr. Rohan was born at Stradbally, Castlegregory, Co. Kerry, and was educated at Aughacasla, N.S. He obtained his certificate at the Atlantic College, Cahirciveen, and served on board a number of well-known vessels. He was also attached to the s.s. *Vonne* when that ship was torpedoed.

OPERATOR DUNCAN MACKINTOSH died on November 4th, 1918, from influenza and malarial fever. He was born at Pityoulish, Aviemore, and was educated at the Rothiemurchus Public School, after which he entered the service of the Bank of Scotland. Mr. Mackintosh received wireless training at the North British Wireless Schools, Glasgow, and was appointed to the Marconi Company's staff on September 17th, 1917.

The operator of the s.s. *Llangorse*, MR. A. J. WALLEY, was landed at Marseilles and admitted to hospital, where he died from influenza on November 31st, 1918. Mr. Walley was a native of Burton-on-Trent, where he was educated at the Guild Street Secondary School. Formerly a telegraph clerk employed in the Midland Railway Company, he entered the Marconi Company's School on August 13th, 1917, and was appointed to the staff on January 6th, 1918.

We learn that MR. EDWARD ALLEN WALL, who was left in hospital at Sydney, N.S., suffering from influenza, died on October 31st, 1918. Formerly a student at the Birmingham Wireless School and a native of that city, Mr. Wall was educated at Grove Lane and Power Street Schools, and was appointed to the Marconi Company's staff on December 12th, 1916. He was attached to the s.s. *Pandion* when she was sunk in a collision and later was on board the s.s. *Spectator* when she was torpedoed.

# ROLL OF HONOUR.





# Our April Issue

## *Interesting Additions and Improvements in the New Volume*

WITH our April issue we open the seventh volume of THE WIRELESS WORLD in conditions which we are glad to say permit us to introduce a number of important additions and improvements. The numerous restrictions which have been placed upon us during the war and many of the difficulties of production which have so seriously handicapped us in the past four years have now been largely removed, and with the opening of the new era of peace we hope to provide in our magazine an abundance of articles and information of great value to the amateur and professional wireless man.

The first change which our readers will observe will be in the cover design. In future we shall provide a change of cover design each month, and our readers will thus be able to gather the main feature of the contents at a glance. The arrangement of the magazine will also be greatly improved, and altogether the magazine will be produced in a more attractive form.

While the main features of our literary contents will be retained, a new and important feature will be provided in a section devoted specially to wireless in its connection with aircraft. The new series of Instructional Articles will be prepared for the benefit of those numerous readers who intend to resume their amateur activities with the removal of existing restrictions and will deal with practical amateur wireless telegraphy and the construction of apparatus. Immediately the future policy of the Government in relation to the amateur is announced articles will be published indicating the best lines for the amateur to pursue, and our Questions and Answers column will deal fully with any queries which our readers may care to submit.

Special features of the April issue will be an interesting illustrated description of the great wireless station at Poldhu, showing the latest type of apparatus installed, and a powerful article by a wireless officer describing the part played by radio-telegraphy in the last phase of the fighting in France and Belgium. Our well-known contributor, Mr. J. Scott Taggart, will provide a valuable article entitled "Practical Notes on Continuous Wave Reception," and other writers will contribute useful articles on other phases of the subject.

As announced in our February issue, the price of THE WIRELESS WORLD in the new volume will be 9d. per copy, instead of 10d., as at present, a change which we think will be much appreciated.

As it is not yet permissible to circulate any magazine on the "sale or return" principle, we would again like to emphasise the importance of placing a definite order for the magazine instead of relying on the possibility of purchasing the copies from the bookstall.

---

## Pay for American Operators

THE United States Shipping Board has fixed the rate of pay for all Chief wireless operators and assistant operators, beginning on January 1st, 1919. The former are to receive 110 dollars a month, and the latter, 85 dollars. There are to be no bonuses and no sliding scale.



# Correspondence

To the Editor, THE WIRELESS WORLD.

Funabashi, Japan, December 19th, 1918.

DEAR SIR,—Atmospheric conditions being most favourable for wireless from October of the year to February or March next, the range of radiotelegraph communication shows a considerable increase during this period. As a consequence, the Funabashi wireless station is now receiving over an amazing distance signals sent by high-powered stations in Europe and America. While it is a fact patent to the world that the large radio-station at Nauen, Germany, rendered great services during the war instructing cruisers and U-boats, especially remarkable was the activity of the station when Germany proposed an armistice to President Wilson last month. The German station then did its utmost to arouse the world's sympathy by broadcasting one after another press messages declaring her miserable internal conditions. These messages being distinctly and regularly received at Funabashi, the miserable state of Germany was made clear to us who are five thousand miles distant from there. Another German station "O.U.I.," probably at Eilvese, working with Madrid, Spain, is picked up by us frequently. We can read easily, too, signals sent from stations "Y.N." and "I.D.O.," at Lyons, France, and Rome, Italy, respectively. The Tuckerton "N.F.F." in New Jersey, which is now under the control of the U.S. Navy, is also being heard here by day and by night, communicating with Lyons or San Diego "N.P.L.," Cal. The distance from Tuckerton, running up to seven thousand miles, is the longest we have ever attained. In view of such great development of radio-telegraphy in late years—one must admit a strong rival of the cable service in the field of international communication—the first and due consideration should be given to the erection of powerful wireless stations instead of discussing the question of laying a cable, which is costly and liable to interruption, in the deep sea.—Yours respectfully,

(Signed) K. JONEMURA  
(Funabashi Wireless Station).

---

WE notice the following letter has been written to the Editor of *The Portsmouth Evening News* :—

"SIR,—Nearly every other town in Great Britain has a wireless society—why not here? There are plenty of enthusiastic wireless men in Portsmouth who would be only too glad to have a meeting place to discuss matters.

"Wireless is a very interesting subject, and there is still much to be done to get the best out of the apparatus used. If you are a wireless man and feel that you want to argue the point, then write to me and we will see what can be done with a view to forming a society.

"W. G. HILL.

"106 Westfield Road, Southsea."

We shall be pleased at all times to give room in our columns to the publication of readers' views on the above or kindred subjects.

---

## SOME INTERESTING CORRESPONDENCE.

A RECENT issue of our esteemed contemporary *The Electrical Review* contains the following letter from Mr. A. A. Campbell Swinton :—

In the interest of historical accuracy, may I protest against the suggestion contained in your article on "Wireless and the War" that Mr. Marconi, when he first arrived in this country, failed to meet with sympathy in official circles?

This is very unfair to the late Sir William Preece, then Chief Engineer to the Post Office, who received Mr. Marconi with open arms and gave him much technical

assistance, including the use of a considerable sum of public money, which was expended in developing wireless telegraphy by numerous experiments carried out with the help of Post Office officials, including Mr. (now Sir) John Gavey.

Official sympathy with inventors is perhaps not very common, but there was certainly no cause for complaint in this particular instance.

(Signed) A. CAMPBELL SWINTON.

Westminster, January 25th, 1919.

As this letter raised a point of considerable importance, Senatore Marconi has forwarded to the editor of *The Electrical Review* the following reply :—

*The Editor of "The Electrical Review" :—*

SIR,—With reference to the letter of Mr. A. A. Campbell Swinton which appears in your issue of January 31st I quite agree with his statement that there is no foundation for the suggestion that when I first came to this country I failed to meet with sympathy in official circles, at any rate so far as the late Sir William Preece, Sir John Gavey and Mr. H. R. Kemp, of the General Post Office, are concerned. It is quite incorrect, however, to say that the assistance of this department "included the use of a considerable sum of public money." This is an allegation which I have repeatedly denied, notably in evidence which I gave in 1907 before the Select Committee of the House of Commons on the Berlin Radiotelegraphic Convention of 1906, and again in 1913 before a Select Committee of the House of Commons appointed to inquire into the agreement of 1912 with the Marconi Company.

In the interests of ordinary—as well as historical—accuracy I cannot do better than to reproduce here two extracts from the aforesaid evidence. In 1907 I said :—

"If you will allow me with reference to a general idea that there is in existence about my early relations with the General Post Office, I wish to state that I shall always feel grateful for the encouragement they gave me and the interest they took in my methods during those early trials. At the same time I would also like to state, on account of a belief that there is about it, that I obtained no financial assistance from the Post Office; fortunately, I did not require it at that time, I only thought it necessary and thought it desirable to interest them in what I was doing and to show them what I could do."

And in 1913 my words were as follows :—

"I think it right to repeat what I stated before the Select Committee on the ratification of the Radiotelegraphic Convention of Berlin, that I feel grateful to the Post Office authorities for the encouragement they gave me and the interest they took in my work during those early trials. I wish, however, most emphatically to state that at no time have I ever received from the Post Office or any Government department anything in the way of a favour which would have been in common courtesy afforded to any scientific worker by any Government in any other country of the world."

Neither Mr. (now Sir) John Gavey, who gave evidence before the 1907 Committee, nor Mr. (now Lord) Buxton, who was then Postmaster-General and who was a member of the Committee, said anything that could be construed as a refutation of the evidence I have reproduced above.

What I greatly regret, however, and, if I may be allowed to say so, this constituted to my mind a mistake on the part of the Post Office, is that I was practically compelled to allow my experiments in South Wales in May, 1897, to be witnessed in all their details by Professor A. Slaby, of the Charlottenburg Technical Institute and a personal friend of the Kaiser. I did not know Professor Slaby nor had I ever expressed the slightest desire to allow him to witness my experiments, but did so out of courtesy to the Post Office officials who introduced him and who made the request.

(Signed) G. MARCONI.

# The Design and Construction of Apparatus for the Wireless Transmission of Photographs

## ARTICLE II.

BEFORE proceeding further, there is one point connected with the last article that requires a little more explanation. In Fig. 3 the numbering of the contacts of the two-way switch *L* was omitted, and this is now given in Fig. 8 accompanying this article. Also in the letterpress relating to Fig. 5, 2 *BA* should read 1 *BA*.

It was the writer's intention to have started in this article the construction of the machine and driving gear, but as the drawings for this are not yet completed it was decided to begin with designs for one or two of the smaller pieces of apparatus required. Although there is a lot of work entailed in the building of such a set as will be described in these articles, there is nothing very complicated in the design of the various pieces of apparatus that will call for more than an ordinary amount of mechanical skill on the part of the builder, and, indeed, should not prove more difficult than the construction of a good wireless station. The efficiency and reliable working qualities of the entire set must, however, if any accurate and serious work is to be attempted, be beyond reproach, as there are numerous pieces of apparatus all requiring fairly delicate adjustment and depending one upon the other for successful working.

The first piece of apparatus to be taken in hand will be the contact-breaker *L*. The general arrangement of this will readily be gathered from a study of Fig. 9,

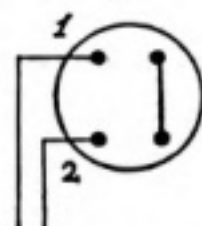

FIG. 8.

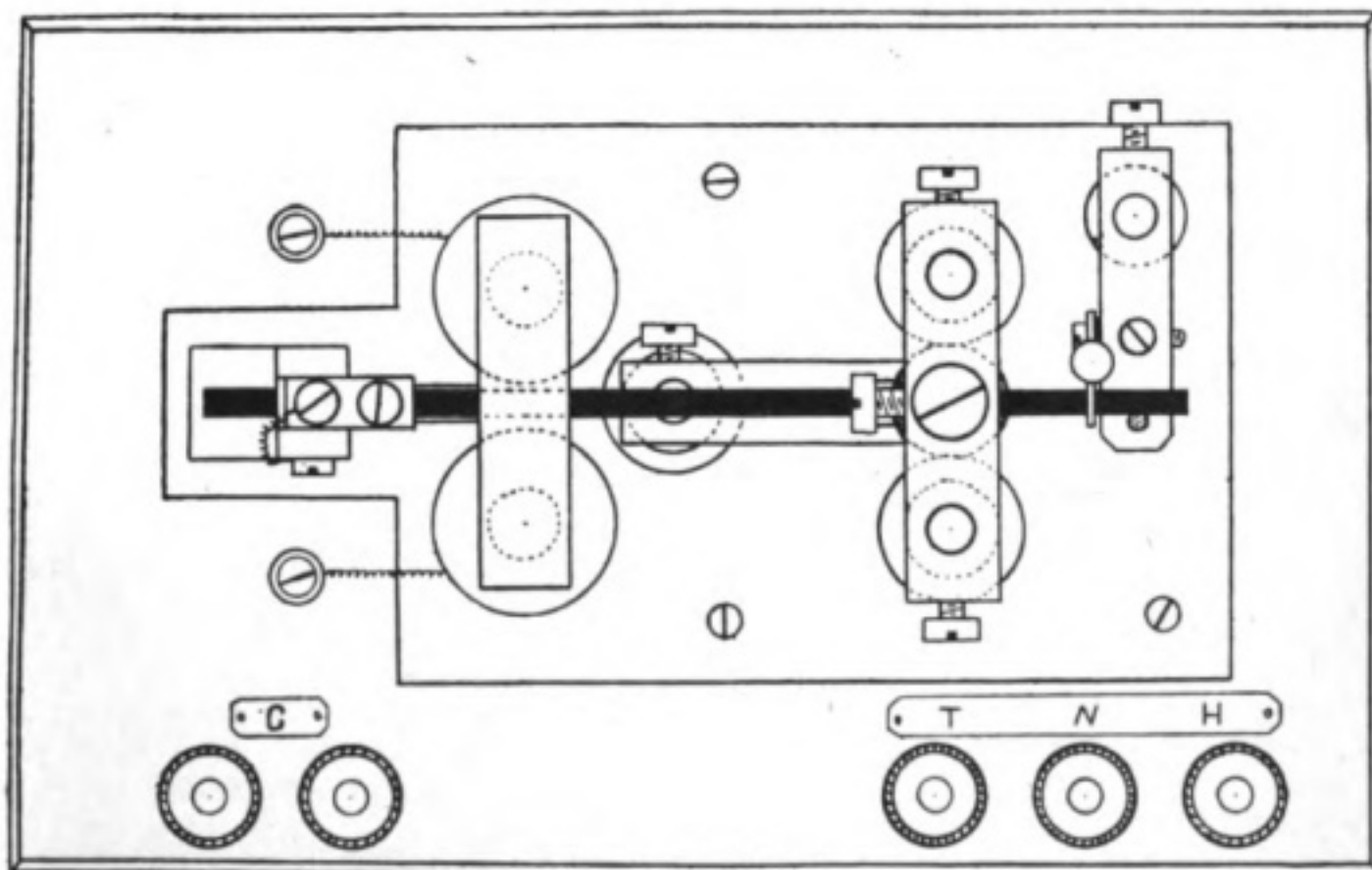

FIG. 9.



and the construction from Figs. 11 to 24. A photograph of the complete instrument is given in Fig. 10.

The baseplate, Fig. 11, is cut from a piece of mild steel  $5\frac{3}{4}$  in. by 3 in. by  $\frac{3}{16}$  in. thick, and should be marked out for drilling as shown. The holes *B* are drilled  $\frac{3}{8}$  in. diameter, the holes *F* are  $\frac{1}{4}$  in. diameter, and the holes *D*  $\frac{3}{16}$  in.

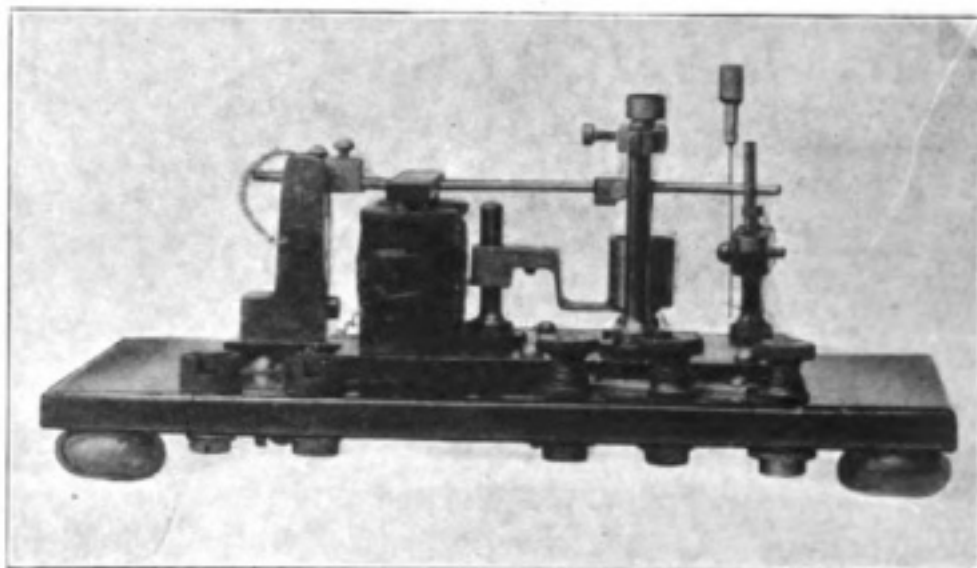
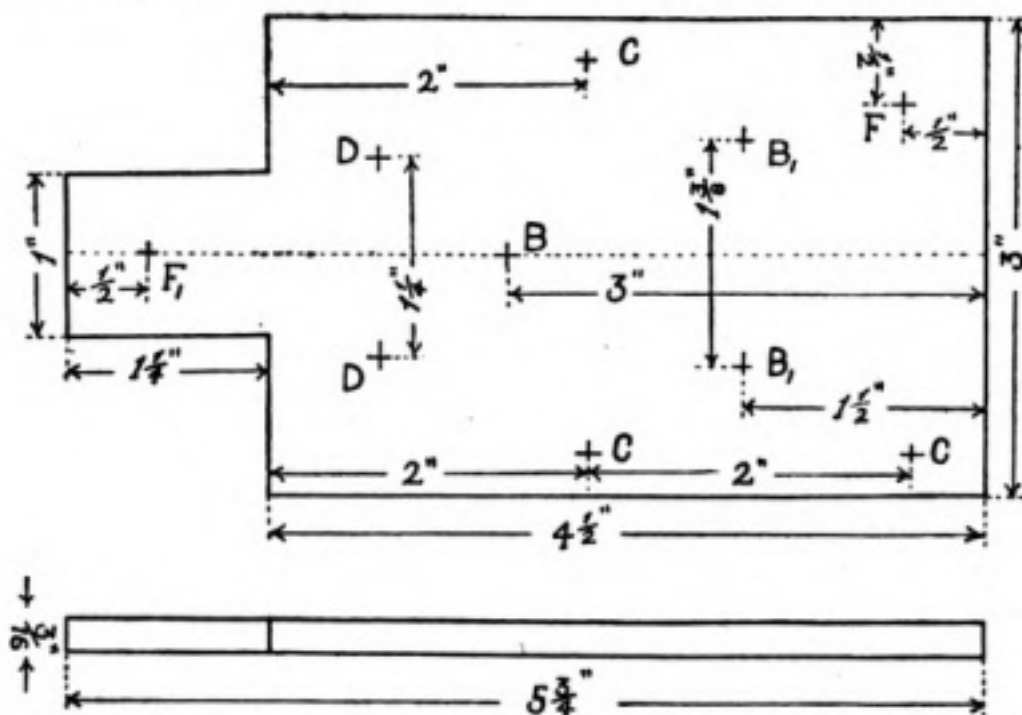
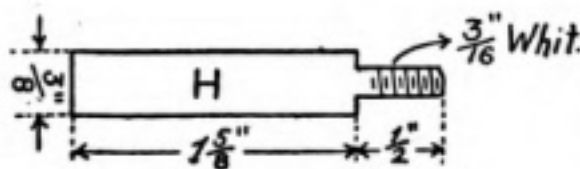

FIG. 10.



1 off.

FIG. 11.



2 off.

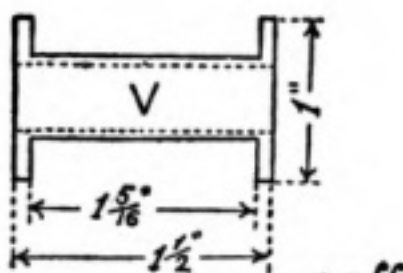

FIG. 12.

diameter. The holes marked *C* are  $\frac{7}{16}$  in. from the edge of the plate, and should be drilled  $\frac{5}{32}$  in. diameter. The magnet cores *H* are turned from a piece of well-annealed iron rod to the dimensions given in Fig. 12, the screwed shanks being a tight fit for the holes *D* in the baseplate. The bobbins *V*, which are 1 in. diameter and  $1\frac{1}{2}$  in. long, are turned from box or other hardwood to the dimensions given in Fig. 12. The  $\frac{3}{8}$ -in. central

hole should be a sliding fit over the iron cores *H*, and the shell turned very thin in order to get the windings as close to the core as possible.

The armature *A*, Fig. 17, consists of a piece of soft iron 2 in. long by  $\frac{1}{2}$  in. wide and  $\frac{1}{16}$  in. thick, and should have a  $\frac{1}{8}$ -in. diameter hole drilled right through the centre of the side as shown. This hole is to take a  $5\frac{1}{2}$  in. length of  $\frac{1}{8}$  in. diameter silver steel rod *S* which is pushed through until  $1\frac{1}{2}$  in. project from one side of the armature, in which position it is secured by closing the metal over the rod by one or two dots made by means of a centre punch. The contact block *C* is of brass, and measures  $\frac{9}{16}$  in. by  $\frac{3}{8}$  in. by  $\frac{3}{32}$  in. In order to reduce weight a recess is filed on one of the narrow edges as

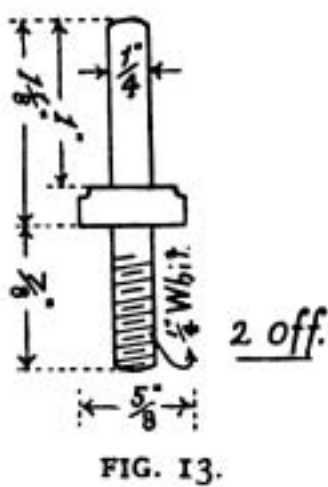

FIG. 13.

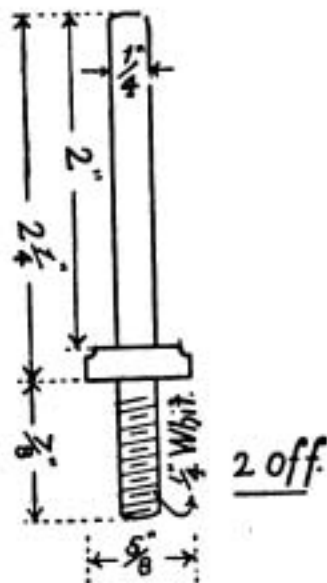

FIG. 14.

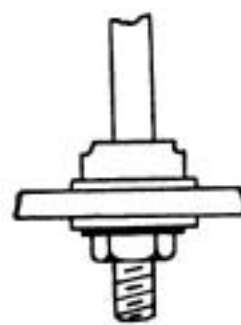

FIG. 14A.

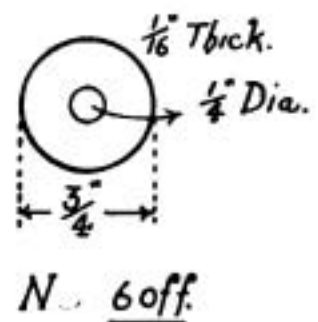

FIG. 15.

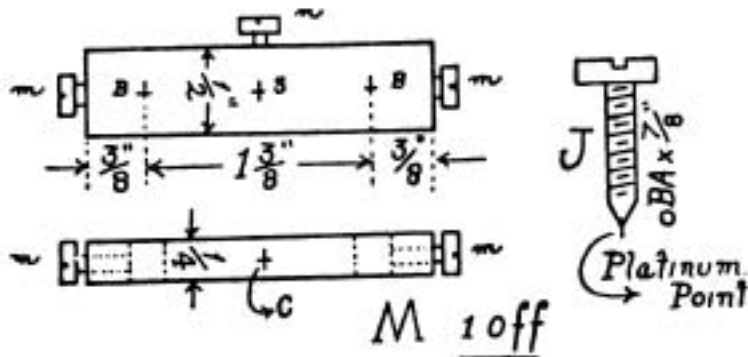

FIG. 16.

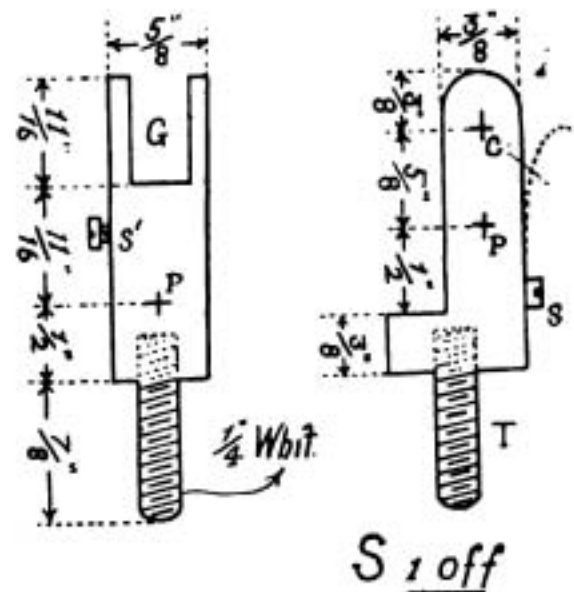

FIG. 18.

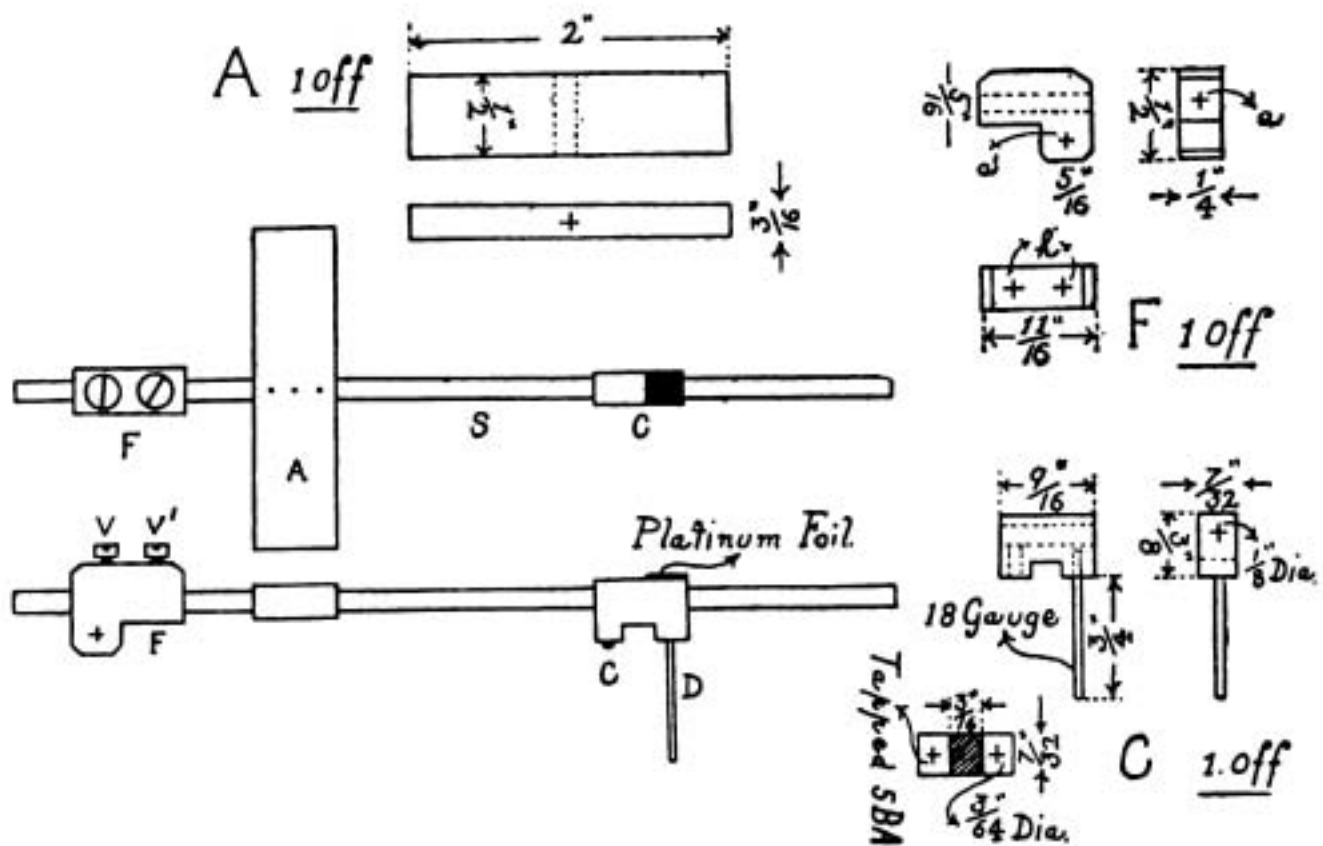

FIG. 17.

shown, and this should be about  $\frac{1}{8}$  in. deep. A  $\frac{1}{8}$ -in. diameter hole is drilled through lengthwise, the centre being  $\frac{1}{8}$  in. from the top edge. Underneath, in the centre of the two portions either side of the recess, two holes are drilled—one drilled and tapped 5BA to take a short grub screw  $\frac{1}{4}$  in. long, and the other drilled  $\frac{3}{8}$  in. to take a  $\frac{3}{4}$  in. length of 18-gauge copper wire *D*, which is soldered in position. The bottom portion of *D* should be well amalgamated, and this can be effected by thoroughly cleaning with a few drops of dilute nitric acid, to which one or two globules of mercury have been added.

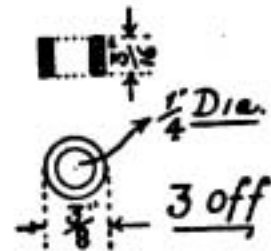

FIG. 19.

The block *F* is cut from a piece of mild steel to the size and shape given in the drawing. The hole *a* is  $\frac{1}{8}$  in. diameter, and should be drilled through lengthwise, the centre being  $\frac{1}{4}$  in. from the top edge. The centre of the hole *a*<sup>1</sup>, which is drilled through the side of the block, is  $\frac{1}{8}$  in. from the top edge, and of such a size that it will move freely upon a piece of  $\frac{1}{8}$ -in. diameter steel. The top edge is marked off for the holes *h*, which are drilled and tapped to take two 4BA cheese-headed brass screws, the screw *V*<sup>1</sup> being used to clamp the block upon the rod *S*. A small piece of platinum foil, about  $\frac{1}{16}$  in. square, should also be soldered to the centre of the top edge of the contact block *C* as shown.

The bearing standard *S*, Fig. 18, can be made from either brass or steel. The slot *G* should be carefully filed out so that the block *F*, Fig. 17, will slide in easily without any side play. The holes *P* are drilled and tapped 4BA, while the hole *c* is drilled a tight fit for a piece of  $\frac{1}{8}$  in. diameter silver steel. The stud *T* is screwed and pinned tightly into the centre of the bottom of the standard, the projecting length being  $\frac{1}{8}$  in. The spring *J*, Fig. 21, is made from a piece of spring steel  $1\frac{1}{8}$  in. long,  $\frac{3}{8}$  in. wide, and about 28 gauge, bent to the shape given in the drawing. The hole *a* is  $\frac{9}{32}$  in. diameter.

The contact screw arm *M*, Fig. 16, is of brass, and measures  $2\frac{1}{8}$  in. by  $\frac{1}{2}$  in. by  $\frac{1}{4}$  in. The hole *S* is drilled and tapped 6BA to take the brass contact screw *J*, while the holes *B* are drilled  $\frac{1}{4}$  in. diameter, and should be a sliding fit upon the standards *B*, Fig. 14. The screws *m*, *n* are 4BA cheese-headed,  $\frac{1}{2}$  in. long, and are for locking the arm and contact screw in position.

Details of the mercury cup are given in Fig. 20. The arm is built up, the block *C* being screwed and soldered to the bent-brass strip *D*. The hole *P* is drilled  $\frac{1}{4}$  in. diameter, and should be a sliding fit upon one of the standards *T*, Fig. 13. The hole *h* is drilled and tapped 2BA to take the locking screw *F*, which is a  $\frac{3}{8}$  in. by 2BA cheese-headed brass screw. The container *S* is turned from either iron or ebonite, and the hole *n* is drilled and countersunk a tight fit for a 3BA steel screw  $\frac{1}{8}$  in. long. The container is held in position upon the arm by means of a nut as shown.

Fig. 22 gives the construction of the spring catch for holding the armature in its working position. The arm *P* is of brass and measures  $1\frac{1}{4}$  in. by  $\frac{1}{2}$  in. by  $\frac{3}{8}$  in., and should be drilled and tapped as shown in the figure. The hole *c* should also be a sliding fit for one of the standards *T*, Fig. 13. The hole *U* should be drilled  $\frac{1}{8}$  in. to take the guide rod *R*, which should be soldered in position. The 4BA screw

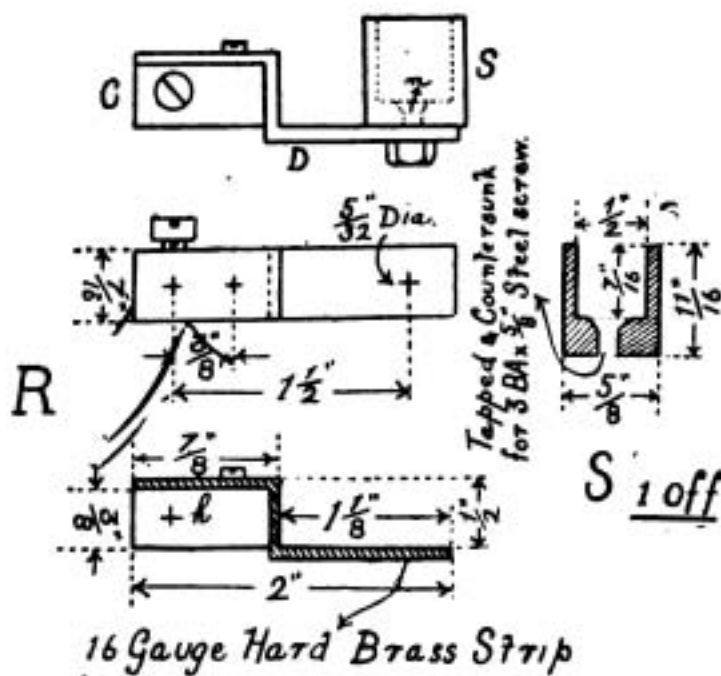

FIG. 20.



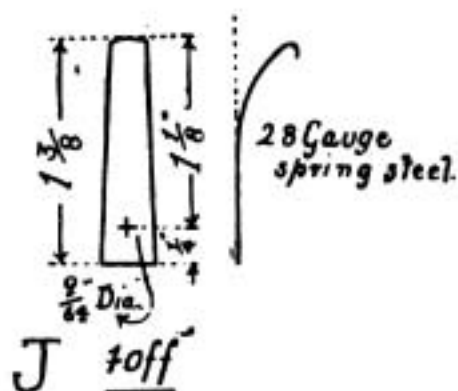

FIG. 21.

*V* is to hold the spring *Q* in position. The catch *Z* is cut from 18-gauge mild steel to the dimensions given, the small handle being built up and soldered on to the catch. The catch complete is shown in Fig. 23. *Z* is held in position upon the arm by the 4BA by  $\frac{1}{2}$  in. steel screw *m*, and should be screwed up so that *Z* is perfectly free to move without any side play. The bent end of the spring *Q* should hook into the small slot cut in the bottom part of *Z*. The hole *v* in the arm is drilled and tapped 4BA to take the screw *d* which locks the screw *m*.

The insulating washers *N*, Fig. 15, are of fibre or ebonite, as are also the bushes, Fig. 19. The bobbins *V*, Fig. 12, are wound with 1 oz. each of No. 33 D.C.C.

wire, the total resistance being 39 ohms.

The instrument can now be assembled. The cores, Fig. 12, are placed in the holes *D* in the baseplate and secured by means of  $\frac{1}{8}$  in. plain nuts. The bushes, Fig. 19, are driven tightly into the  $\frac{3}{8}$  in. holes *B* and filed off flush. The two standards, Fig. 14, are put through the two bushes marked *B*<sup>1</sup>, an insulating washer, Fig. 15, being first placed on either side of the baseplate so as to thoroughly insulate the standards from the rest of the instrument. They are fastened in position by a nut and plain washer as shown in Fig. 14a. One of the standards, Fig. 13, fits into the remaining bushed hole *B*, and is insulated in a similar manner, the other standard being fastened in position in the hole *F*. The bobbins after being wound are slipped over the cores and connected up start to finish. The block *F*, Fig. 17, is fitted into the slot *G* of the bearing standard, Fig. 18, a short length of  $\frac{1}{8}$ -in. silver steel serving as a pivot. The spring, Fig. 21, is screwed to the front of the standard by the 4BA screw *S* as shown in Fig. 18, and the standard, together with the armature, is put in position in the hole *F*<sup>1</sup> in the baseplate. Before clamping finally in position it should be observed that the rod *S* of the armature is in perfect alignment with the centre line of the baseplate. The soft iron armature should be central in both directions over the iron cores, and should sit squarely upon them when held down.

The mercury cup, Fig. 20, is put in position upon the standard fastened at *B*, and the contact screw arm, Fig. 16, slipped over the two long standards and clamped in position, the correct height being 2 in. from the baseplate to the bottom of arm.

The contact screw, which should come opposite the platinum foil upon the contact block, is now screwed down until the armature is about  $\frac{1}{3}$  in. away from the magnet cores, but this adjustment must, of course, be finally made by connecting up with the correct working voltage. The tension of

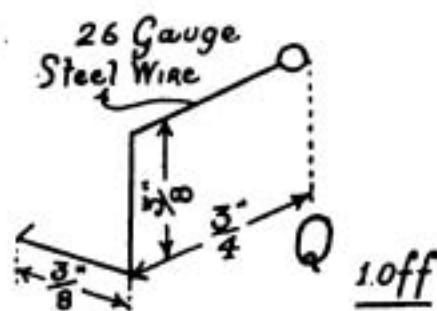
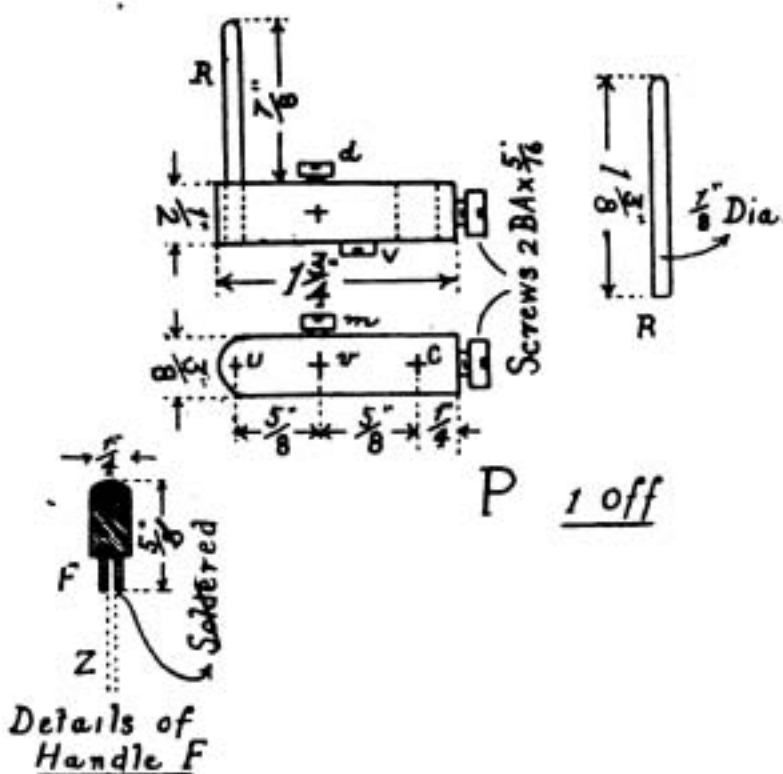

FIG. 22.

the antagonistic spring need only be such that the contact block makes good contact with the contact screw. The mercury cup should be half filled with mercury, and the final position obtained by moving the arm upon the standard until the wire from the contact block is just clear of the surface of the mercury and in the centre of the cup when in normal position; the wire should dip at least  $\frac{1}{4}$  in. into the mercury when the armature is attracted.

The spring catch is next placed in position upon its standard. The correct position is such that when the armature is attracted the hook of the catch can just slide forward over the armature rod, holding this down, and keeping the contact block in permanent contact with the mercury cup. The spring working the catch must have sufficient tension to work crisply, but should not be stiff enough to impede the movement of the armature. The approximate position is given in Fig. 23a. A short length of flexible wire with a small thimble each end, or a close spiral of 22-gauge copper wire, should be clamped under the screw  $V$ , Fig. 17, and the screw  $S^1$  on the bearing standard.

The mahogany stand, details of which can be gathered from the photograph of the finished instrument, measures 8 in. by 6 in. by  $\frac{3}{8}$  in., and is mounted upon four turned feet about 1 in. long. The board is cut away to clear the various nuts underneath the baseplate, and the instrument fastened down by round-headed wood screws through the holes  $C$ , Fig. 11. The disposition of the instrument and terminals, together with the connections, is given in Fig. 24. As shown, the two remaining ends of the coil windings are coiled up and connected to two studs, which are in turn connected to the two left-hand terminals marked  $C$ .



FIG. 23A.

The three terminals marked  $T$ ,  $H$ ,  $N$  are connected as follows: A connection is taken from one of the insulated standards carrying the contact screw to the terminal  $H$ , another from the insulated standard carrying the mercury cup to the terminal  $N$ , and one from the bearing standard to the terminal  $T$ . The shanks of the standards, etc., are long enough to take a second nut for making these connections, which are of 18-gauge copper wire. The terminals should be marked in some way with the letters given in the diagram, preferably by means of small engraved plates which can be screwed to the stand. The terminals  $C$  are connected to terminals No. 12 on the switchboard, and the terminals  $T$ ,  $H$ ,  $N$  to terminals No. 7, which are correspondingly marked. When working, the magnet coils take  $\frac{1}{2}$  ampere at 12 volts, which current can be passed by the polarised relay without damage to the contacts.

No mention has been made with regard to the finish of the instrument, as the finish of this, as well as the remaining pieces of apparatus, will depend upon the ability and inclination of the builder.

(An error occurs in Fig. 24. The letters  $T$ ,  $N$  should be transposed.)

(To be continued.)

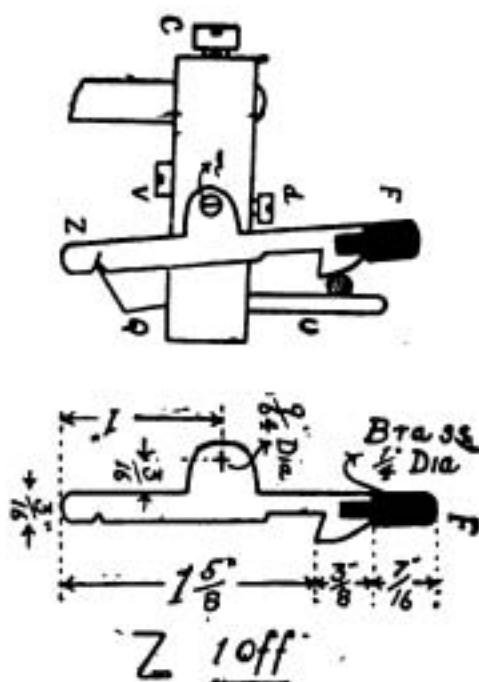

FIG. 23.

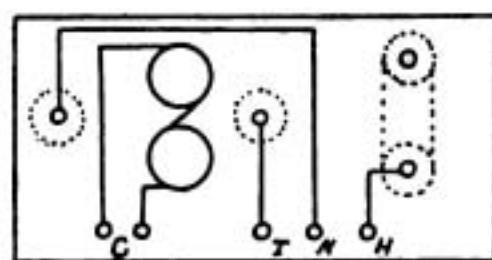

FIG. 24.



# Wireless and Meteorology

## *A Lecture at the Royal Society of Arts*

ON Wednesday, January 22nd, Sir William Napier Shaw, Director of the Meteorological Office, occupied the chair at a meeting of the Royal Society devoted to the reading of a paper by Colonel H. G. Lyons, D.Sc., who took for his subject "Meteorology, during and after the War."

Colonel Lyons had been Director-General of the Survey Department in Egypt, and—after his return to England—had been lent by the Minister of War to the Meteorological Office, subsequently taking over the whole work carried on there. He dealt with his subject from a variety of aspects.

During the war, said he, special facilities were given for the rapid transmission of reports. Kite balloons had been able to furnish a series of observations at various heights. Pilot balloons at perhaps 100 stations were engaged in observations four (or more) times daily. Aeroplanes had been available for observing the temperature in successive layers of the atmosphere up to 12,000 feet or 14,000 feet; whilst the velocity and direction of air currents up to 25,000 feet and more had been determined by the bursting of shells fired at high angles. In these and other ways a vast store of information has been amassed, available for future study.

The lecturer then passed on to emphasize the rapidity of weather changes: "even wireless reports from ships give but a short period of warning in many cases." He adverted, in passing, to the difficulties introduced on the outbreak of war, when simultaneously with all sorts of new disabilities there arose an increased and insistent demand for practical meteorological information, and dwelt effectively upon the contrast between the enemy and ourselves in this respect, pointing his critical remarks with the pregnant observation that this war "is the first in which meteorology has been regularly used" for combatant purposes.

The importance of the subject to the aeroplane service, to kite balloons, and indeed to all forms of aviation, constituted the next item in his discourse. Whilst these new branches of activity made fresh demands upon meteorology, they at the same time introduced fresh aids in its systematization and extension. He referred to the necessity for co-ordination between the four State Meteorological Services now in operation, and then turned to the subject of "Short Period Meteorology" and the Issue of Forecasts. He emphasized the assistance which could be expected from the extension of wireless telegraphy and telephony, expressing a hope that every country will, ere long, be radiating meteorological observations from selected stations four times daily at fixed hours, in much the same way as is followed by the Eiffel Tower station, which sends into the ether Time and Weather Signals thrice per diem. A reference to the peculiarly favourable position of Great Britain, with its far-flung Empire, for the organisation of this important branch of knowledge, closed a highly instructive and interesting paper.

The discussion which followed was opened by the Chairman, who narrated an amusing incident which showed how the assumption, by a practical airman, of the availability of certain information, led directly to its initiation. The Astronomer Royal, Sir F. Watson Dyson, and Colonel L. P. Blandy laid special emphasis upon the necessity for co-relating the work of four different meteorological organisations now in existence. Mr. T. H. Blakesley referred to the daily publication of weather charts by the *Times* and *Morning Post* as evidence of the wider public interest taken in the subject. He deprecated the introduction of unnecessary technical terms such as "millibars." Mr. F. G. Ogilvie and Mr. Carle Salter dealt with the important future before the science, whilst Mr. R. G. K. Lempfert criticised the attitude taken up by the Universities. A brief summation of the discussion by the Chairman and a vote of thanks terminated the proceedings.



# Instructional Article

NEW SERIES (No. 12)

*EDITORIAL NOTE.*—Below we give the last of a series of twelve *Instructional Articles* devoted to PHYSICS FOR WIRELESS STUDENTS. Although at first sight the subject of physics would not seem to have a very intimate connection with wireless telegraphy, yet a sound knowledge of this subject will be found of the greatest use in understanding many of the phenomena met with in everyday radiotelegraphy. As in previous series, the articles are being prepared by a wireless man for wireless men, and will therefore be found of the greatest practical value.

## VALENCY, CHEMICAL AND ELECTRO-CHEMICAL EQUIVALENTS.

### VALENCY.

GENERALLY speaking it may be said that an atom of any element has a definite degree of "affinity" for any other kind of elementary substance. This "affinity" or tendency to combine is explained nowadays by theories dealing with the electrical state of atoms, for details of which the reader must have recourse to an account of the electron theory. In thinking about the "affinity" of an atom we must distinguish between the degree of what may be called its *eagerness* to combine with another kind of matter and the extent to which it actually does so combine. When an atom is in combination with others its *eagerness* to combine with them is precisely the same as it would be were the atom not combined with them, because this eagerness is an inherent quality of all atoms of that particular kind. As a parallel to this we may consider the tendency of a compass needle to set itself in a certain manner relative to a magnetic field; when it has assumed its characteristic position in the field its *tendency* to do so remains the same as ever. But the *extent* to which an atom will combine with others varies, not only according to the particular kind of atoms with which it is brought into contact, but with conditions such as temperature and pressure. Under different conditions an atom will exhibit different combining powers, even with the same class of atoms; yet although this power is variable its degrees are known and can be stated for any given case where the formula is known. Luckily it is not infinitely variable, as will be seen later. Research has shown that there seems to be a well-defined limit to the number of hydrogen atoms with which an atom of another substance will combine, assuming that there are not present any atoms of a third kind. In the case of any *element capable of combining with hydrogen* this number represents its valency, or, to be more precise, it represents its valency as measured by hydrogen; the atom may have more than one valency. Measured in this way the valency of chlorine is 1, because its atom never combines with more than 1 atom of hydrogen. Chlorine, therefore, is called a **monad**; it is monovalent.

Measured by hydrogen. { Oxygen is di-valent. E.g.,  $H_2O$  (Water).  
Phosphorus is tri-valent.\* E.g.,  $PH_3$  (Phosphoretted hydrogen).  
Nitrogen is tri-valent.† E.g.,  $NH_3$  (Ammonia).  
Silicon is tetra-valent. E.g.,  $SiH_4$  (Silicon hydride).

The valency of those elements which will not combine with hydrogen is measured by their capacity to combine with some monovalent element. Thus,

\* Phosphorus is also penta-valent.

† Also penta-valent.

although tin will not combine with hydrogen, if we take the monad chlorine for our standard the valency of this metal is 4. *E.g.*, Stannic chloride,  $\text{SnCl}_4$ .

<i>Measured by chlorine.</i>	{	Sodium is <b>mono</b> -valent. <i>E.g.</i> , $\text{NaCl}$ .
		Calcium is <b>di</b> -valent. <i>E.g.</i> , $\text{CaCl}_2$ .
		Boron is <b>tri</b> -valent. <i>E.g.</i> , $\text{BCl}_3$ .
		Titanium is <b>tetra</b> -valent. <i>E.g.</i> , $\text{TiCl}_4$ .
		Phosphorus is <b>penta</b> -valent. <i>E.g.</i> , $\text{PCl}_5$ .
		Tungsten is <b>hexa</b> -valent. <i>E.g.</i> , $\text{WCl}_6$ .

Most elements possess more than one valency. For example, measured by its combination with hydrogen, phosphorus has a valency of 3; whereas measured by chlorine its valency is 5. In cases such as this the valency of an element is generally given as the *highest number* of monovalent atoms with which its atom will combine.

If an element will not combine with hydrogen it may be capable of *replacing* it during a chemical action, and then its valency is measured by the number of hydrogen atoms replaced. If sodium is brought into contact with water one sodium atom replaces one hydrogen atom in the water, sodium hydrate ( $\text{NaHO}$ ) being formed; hence sodium is monovalent.

There are cases of compounds in which are found atoms with their affinities satisfied partly by one kind of matter and partly by another kind. For example, nitrogen is tri-valent in its combination with hydrogen or chlorine, yet in ammonium chloride ( $\text{NH}_4\text{Cl}$ ), a compound which it forms with both of these elements together, it is *penta*-valent, for its atom is combined with 5 monovalent atoms.

When in a molecule all the atoms are combined to the fullest extent of their valency the compound is said to be saturated. It must be remembered that a trivalent atom can be satisfied equally well by (a) three monovalent atoms (b) one monovalent atom and a divalent atom, or (c) a trivalent atom; the rule applies similarly no matter what valency is considered.

Saturated (Chloride of Boron,  $\text{BCl}_3$ .  
compounds. (Water,  $\text{H}_2\text{O}$ .)

In these cases all the affinities of each element are satisfied.

Unsaturated (Phosphoretted hydrogen,  $\text{PH}_3$ .  
compounds. (Ammonia,  $\text{NH}_3$ .)

In these cases only three of the five affinities of the phosphorus and nitrogen atoms are satisfied. Unsaturated compounds, by virtue of the surplus combining power of their atoms tend, as might be expected, to combine readily with other substances.

There are a number of exceptional cases involving problems which are still outstanding, for valency is in most instances a variable quantity dependent upon prevailing conditions. Helium, Neon, Argon, Krypton, and Xenon have no valency, at least so far as our present knowledge goes, because no compounds of any of these gases have yet been discovered.

The "monovalent atom" which serves as a measure of valency is a working unit, but is not considered to be sufficiently fine, inasmuch as it leads us to state valencies as simple multiples of 1, whereas it is not unlikely that the combining capacity of any element might be more accurately expressed by a mixed number.

### CHEMICAL EQUIVALENTS.

In the foregoing brief explanation we have regarded valency as an inherent property of the atom *exhibiting* itself to a degree dependent upon various conditions, and we have seen its value in a few cases by a reference to formulæ.



There is, however, another means of arriving at the valency of the elements, to understand which the reader must examine the following lists :

- (a) In  $H_2O$  8 parts by weight of O combine with 1 part by weight of H.  
 In  $HCl$  35.5 parts " " Cl " " 1 part " " H.  
 In  $H_2S$  16 parts " " S " " 1 part " " H.
- (b) In  $Cl_2O$  8 parts by weight of O combine with 35.5 parts by weight of Cl.  
 In  $SbCl_3$  16 parts " " S " " 35.5 parts " " Cl.  
 In  $SbCl_3$  40 parts " " Sb " " 35.5 parts " " Cl.

In each of these lists, it will be noticed, there are shown the number of parts by weight of various elements which combine with a certain number of parts by weight of another element. Taking list (a) we see that oxygen, chlorine, and sulphur combine separately with hydrogen in the proportions of 8 : 1, 35.5 : 1, and 16 : 1 respectively. In this sense, therefore, 8 parts by weight of oxygen, 35.5 parts by weight of chlorine, and 16 parts by weight of sulphur are said to be chemically *equivalent*, and the quantities 8, 35.5, and 16 are respectively the **chemical equivalents** of those elements.

Now a peculiar relation exists between the chemical equivalent of an element and its atomic weight, which may be seen by looking at the figures on the left hand side of the above tables (a) and (b). Beginning at oxygen and working downwards, notice the following :

Oxygen	..	Atomic weight	16.	Chemical equivalent	8.	Ratio is	$\frac{16}{8} = 2.$
Chlorine	..	" "	35.5	" "	35.5	" "	$\frac{35.5}{35.5} = 1.$
Sulphur	..	" "	32	" "	16	" "	$\frac{32}{16} = 2.$
Antimony	..	" "	120	" "	40	" "	$\frac{120}{40} = 3.$

In the case of oxygen it is seen that the value of the ratio of its atomic weight to its chemical equivalent is 2 ; this is the *number of hydrogen atoms with which an atom of oxygen will combine* (as in  $H_2O$ , the example given), and this is what has been called the *valency* of oxygen. Following the same idea out in the other cases we find that chlorine is monovalent, sulphur divalent and antimony trivalent. Note that in list (b) the standard is chlorine instead of hydrogen.

It follows, then, that valency may be regarded either as a property of the atom or the ratio of its atomic weight to its chemical equivalent.

### ELECTRO-CHEMICAL EQUIVALENTS.

Conductors of electricity may be divided into two kinds—viz., those which simply become heated when current flows through them, and those which under the same conditions are *electrolysed*, or *decomposed*. For instance, a copper wire becomes hotter when it conducts electricity, but if current is passed through a solution of copper sulphate the latter is decomposed ; metallic copper is deposited on the cathode or negative *terminal* of the battery, whilst the  $(SO_4)$  group passes to the anode or positive *terminal* of the battery and combines with water to form sulphuric acid and oxygen.

If a current is passed through water which has been slightly acidulated with sulphuric acid it is ultimately decomposed into hydrogen and oxygen. Hydrochloric acid yields on electrolysis hydrogen and chlorine. Fig 38 represents an arrangement suitable for the electrolysis of a liquid,  $e$  being the cathode and  $e_1$  the anode ; these two electrodes are platinum strips. Let us suppose that we *shut* the stopcocks and fill up the reservoir and tube  $R$  with slightly acidulated



water.\* On opening the stopcocks the liquid rises in the side tubes, filling them and expelling the air; the stopcocks are then closed again. We will now suppose that a current of 1 ampere is passed through the electrolyte for 1 hour. Hydrogen will be evolved at  $e$  and rise to the surface in bubbles; oxygen will be released at the anode  $e_1$ , and will escape in the same way. At the end of 1 hour we break the circuit and observe the level of the liquid in each side tube. That in the hydrogen tube may have sunk, say, to  $L_1$  in Fig. 38 (a), in which case the level in the oxygen tube will have sunk only to  $L_2$ , that is, only half as far. This demonstrates that the volume of hydrogen evolved by the *same current* is twice that of the oxygen.

Repeating the experiment with hydrochloric acid in the tube we find (Fig. 38 (b)) that hydrogen is evolved at  $e$  and chlorine at  $e_1$ , and that the *volumes are equal*, not only to each other, but also to the volume of hydrogen obtained in the first experiment. If the side tubes are graduated and both experiments are conducted under precisely similar conditions by the simultaneous use of two electrolysis tubes in series with each other and the battery, these results can be very accurately shown.

Now, from what we have learned about atomic weights we know the relative weights of *equal volumes* of hydrogen, chlorine, and oxygen to be respectively 1, 35.5 and 16. Therefore, bearing in mind the *relative volumes* (1, 1 and  $\frac{1}{2}$ ) of these gases released in the experiments, it is easy to see that they must have been released in the proportions **by weight**.

H .. .. 1                      Cl .. .. 35.5                      O .. .. 8

Similarly, if we electrolyse solutions of various salts we get definite amounts of metal deposited on the kathode as a result of the passage of a given quantity of electricity. Taking as a standard that quantity of electricity which will liberate **1 gramme of hydrogen**—viz., **96,540 coulombs**—it is found that this will release or deposit electrolytically:

1	gramme of Hydrogen.
35.5	grammes of Chlorine.
8	" Oxygen.
108	" Silver.
31.7	" Copper (cupric).
63.5	" " (cuprous).
40	" Antimony.

If the reader will refer back he will see that these numbers are the same as the *chemical equivalents* of the elements mentioned; but it is obvious from the

\* The acid is added to assist the decomposition of the water, which by itself is not a good conductor of electricity.

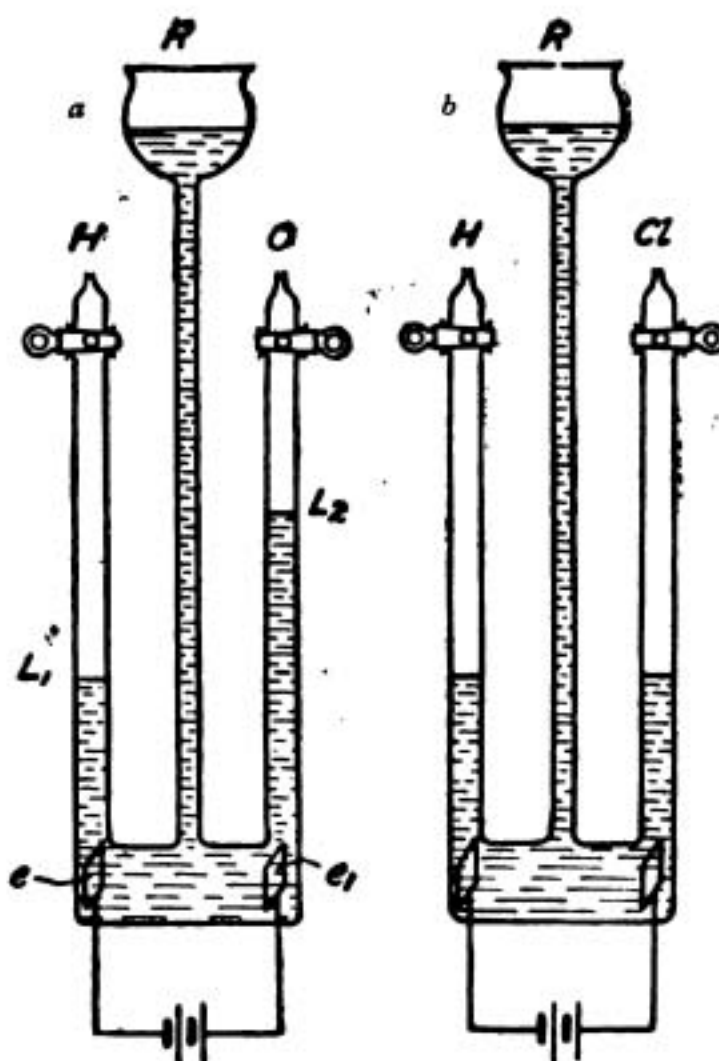

FIG. 38.

list just given that these quantities of the elements are also equivalents in an *electro-chemical* sense. The electro-chemical equivalent of an element is the ratio of its atomic weight to its valency, and is the same as its chemical equivalent.

It will probably occur to the student of electricity that whilst he has seen the electro-chemical equivalent of copper quoted as 0.00328 (C.G.S.) or 0.000328 (ampere equivalent) he has not noticed it referred to as 31.7. This is simply a matter of the size of the units chosen to express the electro-chemical equivalent. The proportion by weight of *copper deposited* to *hydrogen liberated* by any given quantity of electricity is invariable, and is 63:1 or 31.7:1 according to the particular copper salt electrolysed, and the amount of metal deposited by electrolysis is strictly proportional to the quantity of electricity passed. We took as a standard that quantity of electricity which will release 1 gramme of hydrogen because by so doing we arrive at figures which show at a glance that the chemical equivalent of an element is the same as its electro-chemical equivalent, and is the quotient of its atomic weight by its valency. Now the electro-chemical equivalents of the six elements shown in the foregoing list were given in **grammes per 96,540 coulombs**; but the (practical) electro-magnetic unit of quantity is **1 coulomb**, an amount which will liberate  $\frac{1}{96540}$  gramme of hydrogen. Therefore if we consider the electro-chemical equivalent as **grammes liberated per coulomb** we shall come into line with everyday electrical practice, for the **C.G.S. electro-magnetic unit of current is that steady current which will deposit from a solution of copper sulphate 0.003281 gramme of copper\* in 1 second**. One tenth of this current is called an ampere, and, flowing for 1 second, the ampere will deposit 0.0003281 gramme of copper. But the quantity of electricity conveyed by 1 ampere in 1 second is 1 coulomb; hence 1 coulomb will deposit 0.0003281 gramme of copper from a solution of copper sulphate, and this value (0.0003281) is the ampere electro-chemical equivalent of copper.

Let us see whether this is in agreement with the previous statement to the effect that the electro-chemical equivalent of copper is 31.7.

If 96,540 coulombs deposit 31.7 grammes of copper from a solution of copper sulphate, then 1 coulomb will deposit

$$\frac{31.7}{96540} = 0.000328 \text{ gramme.}$$

Thus it is seen that the value of the ratio of the amount of copper deposited to the amount of electricity which deposits it is the same whether we state the electro-chemical equivalent in terms of grammes per 96,540 coulombs, as is often done by chemists, or in terms of grammes per coulomb, as is the custom of electricians.

$$\text{Copper : } \frac{31.7 \text{ (grammes)}}{96,540 \text{ (coulombs)}} = \frac{0.000328 \text{ (gramme)}}{1 \text{ (coulomb)}} = 0.000328.$$

$$\text{Electro-chemical equivalent by method explained above} = \frac{63.5 \text{ (Atomic weight)}}{2 \text{ (Valency in CuSO}_4\text{)}} = 31.7$$

## Share Market Report

A FAIRLY active business has been done in the shares of the various Marconi issues during the past month. Prices are well maintained, the shares of the Marconi International Marine showing a marked improvement. Prices as we go to press are:—Marconi Ordinary, £4 11s. 3d.; Marconi Preference, £3 18s. 9d.; American Marconi, £1 9s.; Canadian Marconi, 12s.; Spanish and General, 13s.; Marconi International Marine, £3 16s. 3d.

\* The Standards Committee of the B. of T. take silver nitrate as the electrolyte. One coulomb deposits 0.001118 gramme of silver.

# The Library Table

7/20/19



*PSYCHIC SCIENCE: An Introduction and Contribution to the Experimental Study of Psychological Phenomena. By Emile Boirac. London: Wm. Rider & Son, Ltd., 8, Paternoster Row, E.C.4. Price 10s. 6d. net.*

Medieval philosophers almost universally maintained that behind everything, material and immaterial alike, there lay some force or first principle to which it all owed its causation. Robert Browning has set forth their philosophy in his *Paracelsus*, the hero of which—imbued with this belief—convinced himself that if he could only attain to this basic principle, he would grasp all knowledge simultaneously; and benefit mankind by obviating the necessity of creeping by slow and painful stages to the revelation of Nature's secrets of existence and creation.

This old idea receives some confirmation from the fact that every great discovery of principle leads directly to a number of others. Thus the formulation of the "germ theory" led to a number of useful discoveries in the somewhat empiric science of medicine.

In a similar way, the exposition of the undulatory theory of light by Thomas Young in 1801 was followed by the discovery of the "Hertzian Waves" later on in the century, and finally crowned by the epoch-making inventions of Marconi. This series of discoveries fired the imagination of scientists, and induced a number of investigators in fields other than electric to proceed along similar lines.

In the book under review there are plain evidences of the influence exerted by radiotelegraphy upon the distinguished French author. For instance:—In speaking of telepathy—*i.e.*, that branch of psychic science which deals with mental suggestion and thought-transmission—he discusses the possibility that "Certain deceased persons concentrated all their powers of expiring thought on beings who are dear to them, and this concentration has, in spite of distance, produced a telepathic impression on the brains of their relatives or friends." Such an explanation of well authenticated phenomena he parallels by illustrations drawn from wireless telegraphy, likening the thought of the dying person to "a kind of spontaneous discharge, similar to that of the electric condenser, immediately followed by oscillations or undulations capable of rapidly traversing great distances and finally disturbing a material object." Again, when dealing with human radiation, an hypothesis which led to our author's conducting some of his most interesting experiments, we find him deprecating astonishment "that a force can thus exist and act in a permanent manner without generally making its existence and action known by any appreciable result," by referring to the fact that "the most recent discoveries of science have already begun to familiarise savants with the notion of such a force. Without speaking of electricity, which was so long ignored, but which, nevertheless, plays so considerable a part in Nature, we will refer to the



" waves known as Hertzian, which accompany electrical discharges and which  
 " traverse all bodies with an inconceivable rapidity. . . . Similarly, the alternative  
 " high frequency currents, studied by Professor d'Arsonval, cross different bodies,  
 " and especially the human body, in such conditions that it is impossible to perceive  
 " their passage ; and yet it is sufficient to modify these conditions, and the individual  
 " whom they traverse may immediately be stunned. We can, moreover, reveal  
 " them by placing in the hands of an individual an electric bulb, which will become  
 " luminous under their influence. It is, therefore, by no means opposed to scientific  
 " analogies to suppose that the human body itself emits radiations of this character."

It would be interesting to pursue the matter further, and to trace the influence exerted by wireless discoveries upon the views of psychic theory adopted by the author, and the lines of investigation which are directly attributable to radio-telegraphic influence. Space, however, does not permit and we must refer readers to the volume itself ; they will find that it amply repays careful study generally, as well as from this specialized point of view.

We would particularly commend to scientific experimenters, who desire to draw correct deductions from the results of their labour, and to avoid the multiplication of useless experiments, M. Emile Boirac's illuminating chapter dealing with the "Paradoxes of Causality." Some of it will, of course, be found familiar by trained observers ; it is, for example, a commonplace that the experimental method consist of four operations : (1) observation, (2) hypothesis, (3) experiment, and (4) induction. But it is by no means so widely remembered (at all events, in practice) that the *order* is of paramount importance. M. Boirac illustrates this fact by instances set forth in a very lucid and informative manner. The error made by the medieval philosophers to whom we refer in our opening sentence was that they mostly reversed the correct rotation of the "Method" enunciated above.

*ITALY'S GREAT WAR AND HER NATIONAL ASPIRATIONS.* By Mario Alberti, General Carlo Corsi, Armando Hidnig, Tomaso Sillani, Attilio Tamaro and Ettore Tolomei. With an Introductory Chapter by H. Nelson Gay. Editors, Alfieri and Lacroix. Milan.

It is by no means due to any desire for employing an elegant periphrasis that we have on several occasions referred to Italy as "the Fatherland of Marconi." The renowned inventor of wireless telegraphy is only one of a long line of illustrious scientists from this ancient centre of civilisation. It is as the living embodiment of an honourable tradition that he represents his Motherland. In many other lands distinguished scientists and men of letters hold themselves aloof from the general life of their country ; this never has been, and is not to-day, the case with Italy. Consequently, when the writers of this compendiumistic volume desire to emphasise the war indebtedness to Italy of France and the world at general they can find no more apposite way of so doing than that of quoting from a speech delivered by Guglielmo Marconi during his visit to the U.S.A.

We recommend any Englishman who is interested in the problems which the Peace Conference at Paris has to solve (and who worthy of the name of Englishman can fail to be deeply concerned therewith?) to get hold of this volume and read it through. It only runs to 267 pages, and compresses the essential features of the whole story within its bulk.

Large numbers of us even yet fail to appreciate the martyrdom of those Italians who were held under Austrian domination in the districts known to the subjects of King Victor Emanuel as "Italia Irredenta" (*unredeemed Italy*). So long was this continued and so thoroughly was the work done, that those ex-subjects of Austria, who were utilised for that Jesuitical Power's fell purpose, are now claiming for themselves, under the title of Yugo-Slavs, large tracts of the country Italy has shed so much blood to save.

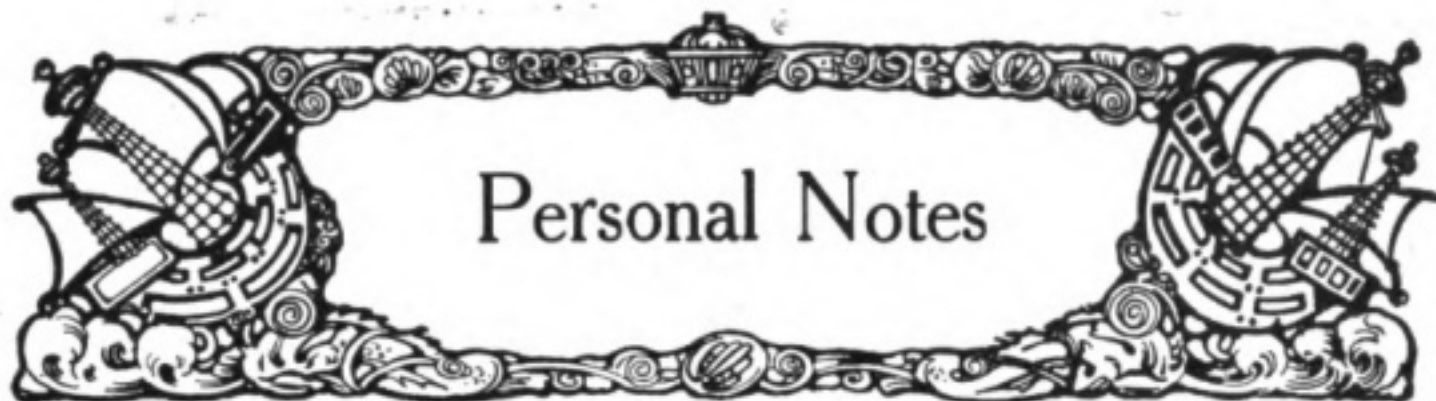

#### MERITORIOUS SERVICE MEDAL FOR WIRELESS WORK.

We have been advised that SERGT. R. J. PARKER has received the M.S.M. for wireless work in Italy during the campaign of 1918. He has been engaged in working direction finding apparatus with excellent results.

#### MENTIONED IN DESPACHES.

Readers of the valuable articles which have appeared from time to time in this magazine from the pen of J. SCOTT TAGGART, R.E., will be interested to learn that this popular author has recently been mentioned in despatches for wireless work during the fighting of 1918. We are also advised that LANCE-CORPORAL R. HEFFER and SAPPER D. GORSUCH, two wireless operators attached to Mr Scott Taggart's section, have been awarded the Military Medal for gallantry in maintaining wireless communication during battle. We take this opportunity of offering our congratulations to these brave men.

The *Journal Telegraphique* announces the nominations of M. JOSEPH HOLLOS to be Director-General of Posts and Telegraphs for Hungary, and M. E. P. WESTERVELD to be Director-General of Posts and Telegraphs for the Netherlands.

#### MILITARY MEDAL FOR R.A.F. WIRELESS OPERATOR.

For devotion to duty with the wireless section of the R.F.C. at Agincourt, of historic fame, AIR MECHANIC H. POTTER has been awarded the Military Medal. Notwithstanding heavy fire, Boche shells frequently falling close to the dugout, Mr. Potter maintained wireless communication under the most difficult circumstances.

#### WIRELESS BOARD.

We understand that the new Wireless Board which has been established under CAPT. R. A. SLEE, R.N., for the purpose of conducting research work is to consist of three naval members, two military members, and two Air Force members.

#### EIFFEL TOWER SIGNALS IN AN ELEMENTARY SCHOOL.

A pioneer of wireless telegraphy in the schools, MR. FRANK HENRY WRIGHT, has died at Bugbrooke, Northamptonshire, aged 66. He was for 32 years a schoolmaster at Bugbrooke, and in the early days of wireless, with the scholars' aid, he extemporised an installation out of crude material. This was erected at the school, and time signals from the Eiffel Tower were regularly taken by the scholars, who shared his enthusiasm in the science. Several scholars have since become wireless operators.

The death is announced of MONSIEUR JOSEPH DE VOLDER, Minister of State and Senator of Belgian Luxembourg. During his lifetime he held the positions of Minister of Justice and Vice-Governor of the Société Générale de Belgique. He was elected President at the inception of the Banque d'Ontremer, The Marconi International Marine Communication Co., Ltd., and the Compagnie de Télégraphie sans Fil, and was connected with these companies for many years.

MR. M. J. HARTIGAN, who joined the Shore Wireless Service in January, 1916, died from influenza on November 26th, 1918. The deceased was an operator in the service of the Marconi International Marine Communication Co., Ltd., previous to the outbreak of war, and his death is deeply regretted by former colleagues.



# Questions & Answers

## ANNOUNCEMENT

We have again received a number of queries from our readers regarding the prospects and conditions in the Mercantile Marine wireless service. Enquiries of this nature should be addressed to:—The Traffic Manager, The Marconi International Marine Communication Company Limited, Marconi House, Strand, London, W.C.2.

**NOTE.**—This section of the magazine is placed at the disposal of all readers who wish to receive advice and information on matters pertaining to both the technical and non-technical sides of wireless telegraphy. Readers should comply with the following rules: (1) Questions should be numbered and written on one side of the paper only, and should not exceed four in number. (2) Queries should be clear and concise. (3) Before sending in their questions readers are advised to search recent numbers to see whether the same queries have not been dealt with before. (4) The Editor cannot undertake to reply to queries by post. (5) All queries must be accompanied by the full name and address of the sender, which is for reference, not for publication. Queries will be answered under the initials and town of the correspondent, or, if so desired, under a "nom-de-plume." (6) During the present restrictions the Editor is unable to answer queries dealing with many constructional matters, and such subjects as call letters, names and positions of stations.

F. H. (Worksop) asks:—What is the difference between a multiphase generator and a monophasic generator, also a multi-pole generator?

**Answer.**—We are not sure whether the question refers to the difference in design of these machines or to the nature of their output. Alternators may be wound in such a manner as to generate a number of separate E.M.F.'s of similar frequencies reaching their maximum values at different instants of time. The output of each winding is a phase, and the armature of a multiphase generator is wound with as many separate windings as there are phases in its output. A monophasic machine is one which generates alternating E.M.F. of one phase only. Multipolar is the name usually given to a generator having more than two poles. A two-pole machine is usually termed bi-polar.

F. H. (Dublin).—Apart from wireless qualifications there is the question of medical fitness. We should suggest that you make application at the local recruiting office.

Miss B. L. (Perth).—You might perhaps arrange a course of instruction in wireless telegraphy at one of the schools advertised in this magazine. We are not aware of any

openings for ladies as wireless operators at the present time.

F. W. N. (Plymouth).—Refer to page 94 of the May, 1918, issue of THE WIRELESS WORLD.

C. P. L. (Egypt).—We do not know of any training school offering free scholarships.

A. L. (Catford).—(1) Suitable applicants in possession of first-class certificates applying to the Traffic Manager are placed on the waiting list to be called upon as the necessity arises. (2) The possibilities of promotion are plainly set forth in the Conditions of Service. See notice at the head of these columns.

A. S. D. (Kensington). asks the following question:—If a steel magnet were to be placed on a pivot inside a circular magnet without a break in it where would the needle point?

**Answer.**—In the first place you do not say whether the steel needle has been magnetised. If the conditions are as above stated the whole of the magnetic flux would be confined to the circular magnetic path surrounding the needle, and presuming there to be no leakage at any point, the needle not being magnetised might take up any position. If the needle were magnetised it would, of course, act as a compass needle and point north and south. In either case the presence of the surrounding magnetic circuit would have no influence on the direction in which the needle would point.

P. C. (Ashton-under-Lyne).—Appendix 5 of the Postmaster-General's handbook for wireless telegraphists indicates the requirements of the Postmaster-General's Examination. A number of schools advertising in this magazine train men for this certificate, without which you cannot sign on as a wireless operator on a British merchant ship. We suggest that you might write for prospectuses.

W. H. (Caton).—(1) For cost of tuition you might write for a prospectus to one of the schools advertising in this magazine. (2) The cost of an outfit would depend upon your personal tastes and present stock of clothing. Previous to the issue of the Mercantile Marine Order, uniform could be procured for about



10. (3) See notice at the head of these columns. (4) For information regarding the requirements of the Postmaster-General's Examination refer to Appendix 5 of the Postmaster-General's handbook for wireless telegraphists.

H. R. L. (West Croydon).—(1) No man is accepted as a student in the Marconi Company's school; it is, at the present time, necessary to possess the Postmaster-General's First Class Certificate. (2) The time required to master the practical side of wireless telegraphy is to some extent dependent upon natural ability. An average student can attain a speed of 20 words per minute in from four to six months. (3) See notice at the head of these columns.

M. P. P. (Bristol).—In order to become a wireless operator on board ship it is necessary to possess the Postmaster-General's Certificate. The requirements of the examination are given in Appendix 5 of the Postmaster-General's handbook of instruction for wireless telegraphists. (2) See answer to P. C. (Ashton-under-Lyme). (3) There are wireless schools at Birmingham and Cardiff, which advertise in this magazine.

F. M. W. (Hitchin).—(1) and (2) At the present moment the question of patents in use by the Government is not decided. In time of war the Government allocate to themselves the right to use any patent which is of sufficient importance. We are therefore not in a position to make a statement as to patentees of the apparatus you mention and for a similar reason are unable to forecast its future. (3) We have received no information whatever as to when the present restrictions regarding private wireless telegraph installations will be withdrawn.

AMBITION (Saltney).—(1) We should be pleased to consider any suggestion you may have for an easy method of learning the Morse code. (2) In case of acceptance the purchase price would be in accordance with the value of the invention. (3) Your question is not at all clear. Does your enquiry relate to a wireless telephone transmitter worked from an induction coil? No system of damped waves is suitable for this purpose. Wireless telephony is carried on almost entirely with continuous waves which cannot be produced by means of apparatus using an interrupter for obtaining high tension.

E. V. D. (Madeira).—There is a magnetometer on the market working on the principle of the increase in resistance of bismuth when acted upon by a magnetic field. This instrument is often used for measuring the field strength of generators, as it can easily be inserted between the pole pieces and the armature. The following data may be of use to you: "With values of the inductance density varying from zero to 40,000 C.G.S. units, the resistance of pure bismuth wire

" will increase nearly threefold. A fine bismuth wire is wound inductively in a spiral coil and encased in a mica capsule, the entire thickness being less than one millimetre. The normal resistance,  $R_0$ , having been measured, it is placed successively in fields of increasing strength, the resistance being measured for each value of  $H$ . A curve showing the relation between the values of  $H$  and  $R$  enables us to interpolate any value of  $H$  for any given value of  $R$ ."—*Electric and Magnetic Measurements*, by Charles M. Smith.

F. J. L. (London) suggests that if an operator is transmitting on continuous waves with very loose coupling the strongest signals will be got by the receiving operator when the coupling in the receiving station is the same value as that of the transmitter. He takes an hypothetical case wherein he assumes that the signals will become inaudible if the coupling at the receiving station is tightened too much.

Answer.—This is not the case. The coupling at the receiving station amongst other things, is dependent upon the damping of the receiving circuits. If heterodyne reception is being employed this will also effect the coupling of the receiver. (2) If the correct coupling is known to be five per cent. at the receiver and the high-frequency transformer in use was wound in the same manner as a low frequency transformer—i.e., for maximum tightness of coupling—the amplitude of the oscillations in the secondary would be largely reduced. Such an arrangement might to some extent be compared to the results obtained when the detecting apparatus is connected directly across the aerial tuning inductance. (3) No system using damped waves is as satisfactory for the purpose of radiotelephony as systems using continuous waves. The Lepel system, which has a fundamental spark frequency above audibility, can be used for this purpose. Experiments have been carried out in this direction with a fair measure of success, but have never reached the same high degree of efficiency as other systems using continuous waves. (4) The Institute of Radio Engineers is an American institution. Their headquarters are at the College of the City of New York. We should suggest that you communicate with the secretary on the subject. Under the heading of "Correspondence" in this issue is a letter dealing with the formation of radio clubs, which may interest you.

C. R. (Hammersmith).—In a rotary spark gap, why should the fixed and moving spark electrodes be adjusted to give a minimum working distance? For example, on small power sets using discs of small diameter and comparatively short waves the peripheral speed of the disc is too low to "quench" the spark. It would appear that if the fixed and moving studs were separated and drawn apart to give a minimum clearance slightly less than the breakdown sparking distance (due to condenser P.D.), then any

low number of oscillations might be obtained in the primary circuit. The decrement due to the greater spark resistance would not be a drawback in this case.

*Answer.*—Whether the distance between the fixed electrodes and the moving studs be adjusted to the minimum working length or to a maximum length would not alter the fact that the whole of each train of oscillations would be completed whilst the moving electrode was underneath the fixed electrode, unless the peripheral speed of the disc was sufficiently high to produce a quenching action. Your suggestion to increase the length between the fixed and moving electrodes would not produce quenching, but would merely lessen the length of each train of oscillations by the amount of energy lost in heat in overcoming the increased spark gap resistance. It seems to us that you are not clear on the subject of quenching itself. Quenching may be defined as the early stoppage of the primary current brought about by the extinction of the spark. The disappearance of the spark opens the primary circuit and leaves the secondary free to oscillate with its own frequency.

*Question 2.*—In a multiple plate quenched gap, Mr. Bangay attributes the "quenching" to the rapid conduction and dispersion of heat by the plates. Yet E. F. Bucher, in *Practical Wireless Telegraphy*, insists that the gaps must be airtight, which would hamper cooling. Is not the quenching partly due to the fact that the heat of the spark expands the air in the gaps, thus increasing the pressure and dielectric strength until this becomes prohibitive?

*Answer.*—Although the quenching action of a multiple plate gap may be attributed to a number of causes yet they can all be traced to the rate at which the heat generated in the gap is dissipated. For instance, it is held by some writers that the extinction of the spark is due to deionisation of the gases between the plates. The rate at which this occurs is to some extent dependent on the rate at which heat is dissipated. Mr. Bucher's explanation also involves the rate of heat dissipation, inasmuch as it would govern the rate at which the air is expanded and hence the degree of quenching obtained.

*Answer to Question 3.*—It is claimed that the mis-tuning of the open and closed circuits facilitates the quenching action, and since tightening the coupling involves a higher rate of energy transference from one circuit to the other, one would naturally expect the quenching action would require to be stimulated.

*Question 4.*—What determines the amount of magnetic leakage in a charging circuit (alternator, or alternator and transformer), and why?

*Answer.*—Your question is rather vague. If you mean what factors in the design govern the magnetic leakage the subject is too lengthy to enter into here and we would refer you to some textbook dealing with design of dynamo

electric machinery. On the other hand, if your enquiry relates to the amount of magnetic leakage required in a charging circuit, we would point out that since the condenser being charged acts as an energy reservoir tending to produce a current lead, magnetic leakage acts in the opposite direction and tends to produce current lag, and thus counteracts the effect of capacity in the charging circuit.

*WINDY (Cologne).*—The time required to qualify would depend upon the present state of your knowledge and natural ability. Under the circumstances we should think about three to four months. (2) At the present time only those applicants in possession of First Class P.M.G. Certificates are placed on the waiting list of the Marconi Company. (3) See notice at the head of these columns. (4) We would suggest that you write to some of the schools advertising in this magazine for copies of their prospectus.

*S. P. (Sudan).*—The secondaries of the transformer which you mention should always be joined in series on the principle that E.M.F.'s in series add together. Similarly, if the primaries are joined in parallel the secondary potential is reduced, and hence the failure of the spark. (2) The phenomenon which you mention might be classed as frictional electricity. (3) We should think the sparking which occurred between the alternator and motor must have been due to induction of high-frequency currents. In order to avoid this trouble it is usual to place guard lamps across the D.C. and A.C. brushes, or else to earth them through a suitable condenser system. (4) The time required would depend entirely on the present state of your knowledge. As regards cost we should suggest you write for prospectus to one of the schools advertising in this magazine.

*A. C. (Baerle-Duc).*—The ratio of transformation and sizes of wire used in the winding of telephone transformers for use with valve amplifiers depend upon the particular valves with which they are to be employed. In general the external resistance of the plate circuit should be approximately equal to the average internal resistance of the valve. We cannot give the inductivity of celluloid. Dr. Eccles states that a number of dielectrics approximately follow the law. Inductivity equals  $2.6 \times$  density.

---

**SITUATION** as "Wireless Instructor" by experienced man, late "Royal Navy," thorough knowledge all systems. —Apply (S) Harrow View Road, Ealing, W.3.

---

**UNIFORM AND BRIDGE COAT** for sale, hardly worn, braid in excellent condition. Original price £6 6s. 0d. each. —S. R. SHILLAKER, 25, Linton Road, Leytonstone, N.E.

**To obtain "THE WIRELESS WORLD" you must place a standing order with your newsagent or subscribe for it through the Publishers.**



# E.C.C.

DYNAMOS,  
MOTORS,  
MOTOR-GENERATORS,  
ROTARY CONVERTERS,  
BOOSTERS, and  
SWITCHGEAR.

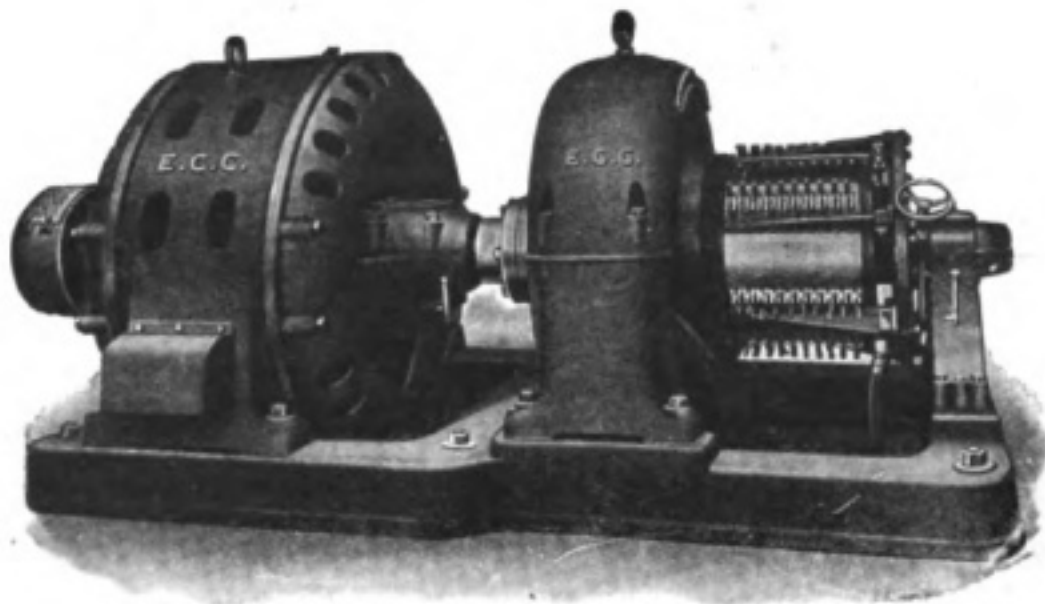

125 Kw. Singlephase to D.C. Induction Motor-Generator 575 r.p.m.

**THE ELECTRIC CONSTRUCTION  
CO., LTD.**

HEAD OFFICE:

Dashwood House, 9, New Broad Street, LONDON, E.C.

Works : Bushbury, WOLVERHAMPTON.



## "GARDNER" ENGINES

FOR  
WELDING  
PLANTS,  
&c.

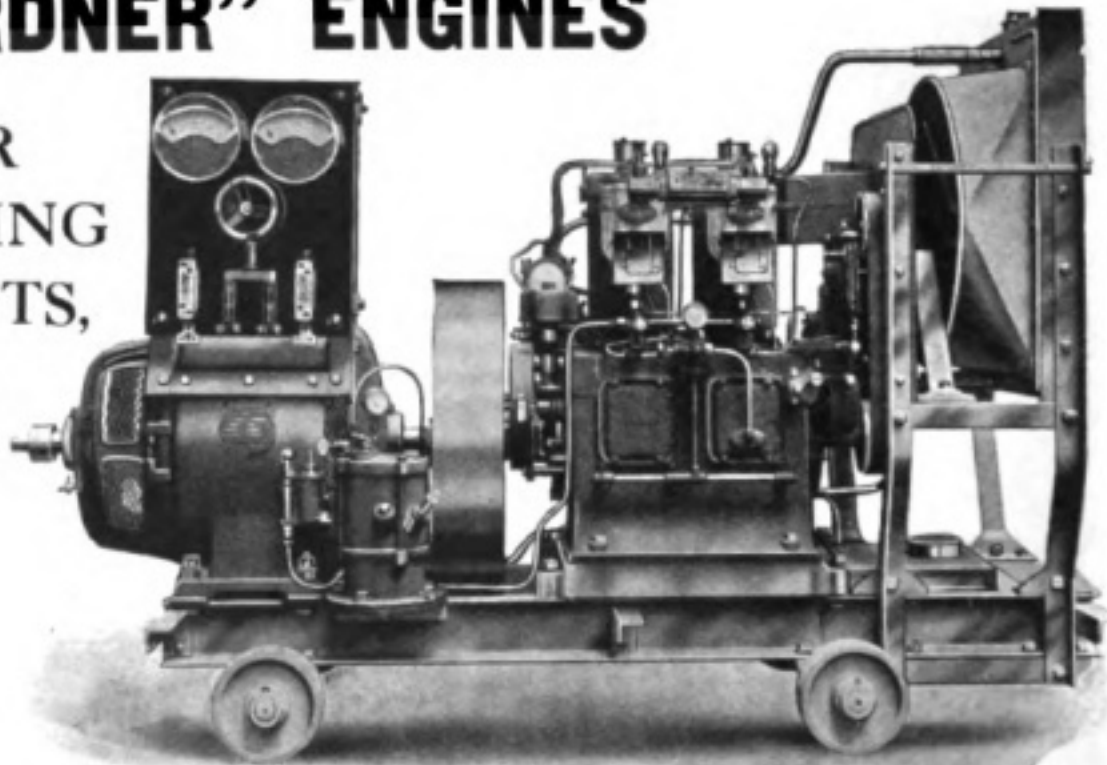

**NORRIS, HENTY & GARDNERS, LTD.**

87 Queen Victoria Street, LONDON, E.C.4

Works: PATRICROFT, ENG.

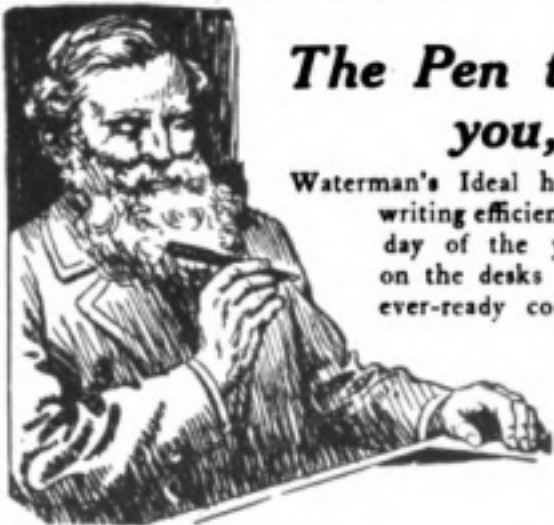

*The Pen that will be young when  
you, yourself, are old.*

Waterman's Ideal has for two generations been the foremost tool of writing efficiency and dispatch. Every minute of the day and every day of the year it saves valuable time. In the pockets and on the desks of those who do things it is an ever-present and ever-ready companion to progress.

Waterman's Ideal is first and last the Fountain Pen of service. It is the one that has life-long durability and reliability, the fountain pen that has the famous spoon feed and other exclusive features of merit. It is the pen which gives that kind of service which has resulted in its world-wide endorsement and use.

# Waterman's Ideal Fountain Pen

Waterman's Ideals are made in three types: Pocket Self-filling, Safety, and Regular. Specially recommended: for Active Service, No. 54 (Self-filling), 20/-; No. 44 (Safety), 20/-; for Business use, No. 15 (Regular), 21/-. Of Stationers and Jewellers. Fullest satisfaction guaranteed. Nibs exchangeable if not suitable. Call or send to "The Pen Corner." Full range of pens on view for inspection and trial.

L. G. SLOAN, Ltd., **The Pen Corner**, Kingsway, London, W.C.2.

And 39, SHAFTESBURY AVENUE, LONDON, W.1.



Please mention "The Wireless World" when writing to Advertisers.

Digitized by Google

Original from  
UNIVERSITY OF MICHIGAN

DIRECT CURRENT  
**DYNAMOS & MOTORS**

STEAM & PETROL SETS FOR  
**WIRELESS & SHIP LIGHTING.**

We specialise in a range from 1 to 150 H.P. of various types.

They represent the latest practice in every detail, as we make nothing else.

They are in accordance with the latest international rating, and our manufacturing methods enable us to quote competitive prices.

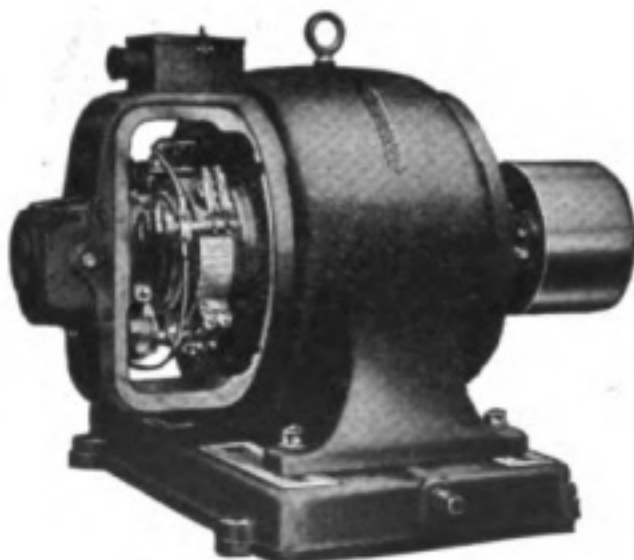

British Built  
 with British  
 Capital, Labour  
 and Materials.

"Magnet," Manchester. 7094 Central  
 "Orders," Cannon, London. 5370 City.

*Electromotors  
 Limited*

OPENSHAW :

Manchester, England.

London, 49 Queen Victoria Street, E.C.

*High Frequency Transformers*

We specialise in High Frequency Transformers, and behind every detail in their construction is an experience extending from the earliest days of the Electrical Industry.

We invite your enquiries, as also for SWITCHBOARDS, HOT WIRE AND FREQUENCY METERS.

**JOHNSON & PHILLIPS, Ltd.,**  
Cable Makers & Specialists in the Transmission & Distribution.  
**CHARLTON,  
LONDON, S.E.7.**



1883

THE  
**WHITECROSS Co.**  
WARRINGTON Ltd.

Manufacturers  
of All Descriptions of

**WIRE**  
and  
**WIRE ROPES**



**City of Cardiff Education Committee.**

THE TECHNICAL COLLEGE.  
Principal—CHARLES COLES, B.Sc.(Lond.)

The services of the following Full-time Lecturer are required:—

LECTURER IN WIRELESS  
(Marine Technical Department).

Commencing salary £350 per annum.

Applications on foolscap paper, stating age, full qualifications, teaching and other experience, and giving copies of not more than three testimonials, should reach the Principal (from whom further particulars may be obtained) by the 17th March, 1919.

Relatives of eligible men on War Service are requested to bring this advertisement to their notice.

JOHN J. JACKSON, B.A.,  
*Director of Education,*  
City Hall, Cardiff.

**D. P.**  
**STORAGE**  
**BATTERIES**

**The D. P. Battery Co.**  
LIMITED  
BAKEWELL DERBYSHIRE

— and —  
No. 11 Victoria Street,  
WESTMINSTER, S.W.1.

Please mention "The Wireless World" when writing to Advertisers.



## INDEX TO ADVERTISERS.

	PAGE
Anglo-French Music Co., Ltd. ... ..	xiv
Atlantic College of Wireless & Cable Telegraphy ... ..	xii
Boyd Brothers, Ltd. ... ..	xvi
British and Foreign Sailors' Society ... ..	xiv
British School of Telegraphy, Ltd., The ... ..	2 Cover
Bryman, P. ... ..	xxiii
Burberrys ... ..	vii
Chloride Electrical Storage Co., Ltd., The ... ..	viii
City of Cardiff Education Committee ... ..	vi
City School of Wireless Telegraphy, Ltd. ... ..	xxvii
Commercial Union Assurance Co., Ltd. ... ..	2 Cover
Compagnie Française Maritime et Coloniale de Télé- graphie sans Fil ... ..	x
Coubro & Scrutton ... ..	xix
Crompton & Co., Ltd. ... ..	xix
Dale & Hollins ... ..	xxi
Davis & Timmins, Ltd. ... ..	x
D.P. Battery Co., Ltd., The ... ..	vi
East London Wireless Telegraph College ... ..	ix
Electric Construction Co., Ltd., The ... ..	iii
Electromotors Limited ... ..	v
Ellis, J. & H. ... ..	xxi
Fisher & Co., Ltd., Eden ... ..	3 Cover
Gamage, A. W., Ltd. ... ..	xx
Graham & Latham, Ltd. ... ..	xxvi
Griffiths Bros. & Co. ... ..	1 Cover
Harveys' ... ..	xv
Henley's Telegraph Works Co., Ltd., W. T. ... ..	viii
Johnson & Phillips, Ltd. ... ..	vi
Liverpool Victoria Friendly Society ... ..	xxvi
London Telegraph Training College, Ltd., The ... ..	xvi
Mackie & Co., W. ... ..	xxii
Marconi International Code Co., Ltd. ... ..	viii
Marconi International Marine Communication Co., Ltd. ... ..	xxv
Marconi's Wireless Telegraph Co., Ltd. ... ..	xxiv
Marshall & Co., P. ... ..	xxviii
Miller, Rayner & Haysom, Ltd. ... ..	xxviii
Munro, J., & Co., Ltd. ... ..	xviii
Nalder Bros. & Thompson, Ltd. ... ..	3 Cover
Norris, Henty & Gardner, Ltd. ... ..	iv
North British & Mercantile Insurance Co. ... ..	xii
North-Eastern Schools of Wireless Telegraphy, The ... ..	xxiii
Officine Elettro-Meccaniche Societa Anonima ... ..	xxiii
Ormiston & Sons, P. ... ..	2 Cover
Paterson, Lt., J. & M. ... ..	xxvii
Pelman Institute, The ... ..	xi
Pinchin, Johnson & Co., Ltd. ... ..	xxi
Samuel Bros., Ltd. ... ..	xii
Sands & Graham, Ltd. ... ..	xxvi
Self & Son ... ..	xvii
Simmonds Bros., Ltd. ... ..	3 Cover
Simplex Conduits, Ltd. ... ..	xviii
Sloan, L. G., Ltd. ... ..	iv
Snewin & Sons, Ltd., C. B. N. ... ..	xxvi
South Wales Wireless College, Ltd. ... ..	xviii
Sullivan, H. W. ... ..	2 Cover
University Engineering College ... ..	xviii
Waverly Book Co., Ltd. ... ..	x
Weston Electrical Instrument Co. ... ..	xvii
Whitecross Co., Ltd., The ... ..	vi
Widnes Foundry ... ..	4 Cover
Willcox & Co., Ltd., W. H. ... ..	3 Cover
Wireless Press, Ltd., The ... ..	xiii, xviii, xx, xxviii
Zodiac, The ... ..	xxvi

# THE BURBERRY

## Naval Weatherproof

is an indispensable part of a Wireless Officer's equipment, affording a safeguard of unrivalled efficiency against wet, cold, and wind, in all parts of the world.

Unlike macintosh or rubber-proofed coats, The Burberry ventilates naturally and is hygienic under all conditions and temperatures, while its durability makes it a most economical investment.

**Complete  
Kits in  
2 to 4 days  
or Ready  
for imme-  
diate use.**

Naval  
Catalogue  
Post Free  
on request.

Every  
Burberry  
Garment  
bears a  
Burberry  
Label.



Until Peace is signed, Officers' Service Burberry  
Weatherproofs CLEANED & RE-PROOFED  
**FREE OF CHARGE.**

**BURBERRYS** HAYMARKET  
LONDON, S.W.1  
8 & 10 BD. MALESHERBES, PARIS; also AGENTS





# SELF

## THE MOST WONDERFUL STUDY IN THE WORLD

**T**HE most popular study to-day is the study of Self. Men and women of all classes and all ages are eagerly studying Self as they never before studied it. Everybody agrees that it is the most fascinating study ever known.

The fact is that we are much more wonderful and much more interesting than we were aware. Those who have been studying Self are every day making astonishing discoveries about themselves and their possibilities.

"I can scarcely believe this is I," exclaims one lady, after completing her study of "the little grey books" in which the true gospel of Self is so interestingly expounded.

"I am now doing things and earning an income that, a year ago, I would have declared to be impossible," says a business manager (formerly a clerk) who was enabled by the same means to achieve Self-Realisation.

It is this kind of unexpected and un hoped-for result which is making Pelmanism and the "little grey books" famous wherever the English language is spoken.

There is no corner of the British Empire—however remote—in which Pelmanism is not known and valued.

Similarly, there is no walk of life, from the humblest to the very highest—including Royalty—in which you cannot find men and women ready to attribute a large measure of their success and wellbeing to Pelmanism.

Many people are sceptical at first; it seems impossible that half-an-hour's study a day can do so much. Yet the facts are incontestable, and they cover every field of human interest.

The "half hour daily" (for a few weeks) has meant double and treble incomes for many hundreds; to others it has meant quick promotion and better positions. British Generals in France have found it help them greatly in active war operations—over 100,000 British officers and men have taken up Pelmanism "for keeps."

Professional men—lawyers, doctors, clergymen, teachers, authors, architects, etc.—have found that Pelmanism enables them to make rapid strides in their vocation: has given them self-confidence, quickened their flow of ideas, made them stronger and fitter mentally.

Women are enthusiastic Pelmanists, and none have more convincingly proved the sterling value of this wonderful new movement as a means of rapidly gaining knowledge, experience, and the arts of success.

But it is not only as a business help that Pelmanism is so great: it adds to the interest and charm of all life. There are many thousands of people who declare that Pelmanism has indeed unfolded a new world for them.

Listen to what a legal gentleman wrote. He was, at the beginning, very incredulous about Pelmanism, but before he had gone half through the Course he wrote:—"I used to think that the claims made for Pelmanism were fantastic:

now I consider them to be under-statements of the truth. Any one of the little grey books is worth £100 to me."

Many clerks, shop assistants, and salesmen tell how they doubled and trebled their incomes as the result of a few weeks' study of the Pelman Course. Tradesmen tell of "record turnover" and 100 per cent. and 200 per cent. increase in profits. The latest batch of reports from Pelman students (including men and women of all occupations in life) show that less than one per cent.—not one in a hundred—failed to gain substantial advantages from the Pelman Course.

And all at the price of half an hour or so a day for a few weeks! It sounds too good to be true; but there are thousands of letters to prove that it is absolutely true. There is not a class, not a business or trade or profession in these islands, in which Pelmanism has not proved itself a wonderful help to success. That is to say, a means of increasing efficiency and developing "braininess" to such a degree that promotion and a bigger salary follow as surely as night follows day.

Women are particularly keen on Pelmanism; it has proved such an enormous help to them in "getting on" in business. Many of them describe it as "the best investment I ever made."

Moreover, they find it a truly fascinating study. "I am genuinely sorry the course is finished. I have found it so absorbingly interesting as well as profitable." These are the exact words used by students of the Pelman Course.

TRUTH has made another report upon the progress of Pelmanism amongst various classes, and confesses it would be impossible to name a business, profession, or vocation in which there were not hundreds of Pelman students.

So many people doubt because the benefits appear to be so great; yet the most remarkable cases are never published. Pelman announcements often refer to 200 per cent. and 300 per cent. increases of income gained through Pelmanism; but one man at least has testified to the fact that his income was increased by over 600 per cent! It certainly seems as though Pelmanism is "worth while." At least this is the belief of the 400,000 (and more) men and women who have already adopted this fascinating science of Self-Study and Self-Realisation.

*Full particulars of the Pelman Course are given in "Mind and Memory," which also contains a complete descriptive Synopsis of the 12 lessons. A copy of this interesting booklet, together with a full reprint of "Truth's" famous Report on the work of the Pelman Institute, and particulars showing how you can secure the complete Course at a reduced fee, may be obtained gratis and post free by any reader of THE WIRELESS WORLD who applies to The Pelman Institute, 145 Pelman House, Bloomsbury Street, London, W.C.1.*



# ATLANTIC COLLEGE

OF

**Wireless and Submarine  
Telegraphy, Cahirciveen.**

Send your boy to the centre of the  
Telegraphic World, to learn Wire-  
less or Submarine Telegraphy.

**Most Successful Tuition  
by fully qualified Staff.**

Students can qualify for shore appoint-  
ments, as the College is equipped with the  
most complete and up-to-date Wireless  
Plant in Ireland—an exact facsimile of  
Shore and Ship installations.

*Illustrated Prospectus on application to*

**M. M. FITZGERALD, A.M.I.E.E.,**  
*Principal.*

ESTABLISHED 1809

**NORTH BRITISH  
& MERCANTILE  
INSURANCE COMPANY**

**FIRE LIFE  
ACCIDENT ANNUITIES  
BURGLARY MARINE**

**Funds £23,750,000**

Chief Offices:

**LONDON: 61 Threadneedle Street, E.C.2**

**EDINBURGH: 64 Princes Street.**

**CAP  
BADGES IN  
ANY  
DESIGN**

**NAVAL TRENCH COATS,  
OILSKINS, BRITISH WARMS,  
ready to wear or to measure  
at short notice.**

THIRD SECOND FIRST

## SAMUEL BROTHERS, L<sup>TD</sup>

*Naval & Military Outfitters*

Regulation Wireless  
and  
Mercantile Marine  
Uniforms.

Reliable Indigo-dyed Cloths  
and best quality Laces only  
used.

Price List on Application.

**65 & 67 LUDGATE HILL, E.C.** 'Phone: 3030 CITY  
Within 3 minutes' Bus ride of Marconi House.

And at OXFORD CIRCUS, W. (221 and 223 Oxford St.), 'Phone: 4664 MAYFAIR.

*Please mention "The Wireless World" when writing to Advertisers.*

PUBLICATIONS OF  
**THE WIRELESS PRESS, LIMITED**  
 MARCONI HOUSE, STRAND, LONDON, W.C.2.

**The Year Book of Wireless Telegraphy and Telephony, 1918.**

Out of Print.

**The Wireless Telegraphists' Pocket Book of Notes, Formulæ and Calculations.**

By Dr. J. A. FLEMING, M.A., D.Sc., F.R.S., M.Inst.E.E., etc. A valuable compendium for Wireless Engineers and Operators. Price 9/- net. (Postage 5d.)

**The Handbook of Technical Instruction for Wireless Telegraphists.**

By J. C. HAWKHEAD and H. M. DOWSETT. Second Edition. Thoroughly revised. Provides a complete theoretical course for the Postmaster-General's certificate of proficiency. 344 pages. 240 diagrams and illustrations. Price 6/- net. (Postage 6d.)

**The Elementary Principles of Wireless Telegraphy.**

By R. D. BANGAY. In two parts. Price 3/- each. (Postage 4d.) Or in one volume, price 6/- net. (Postage 6d.) Invaluable for instructional purposes. Used by H.M. Government.

**Magnetism and Electricity for Home Study.**

By H. E. PENROSE. Crown 8vo. Over 500 pages. Contains a course of 50 Lessons particularly useful to the home student without previous knowledge. Price 5/- net. (Postage 6d.)

**The Wireless Transmission of Photographs.**

By MARCUS J. MARTIN. Price 2/6 net. (Postage 4d.)

**The Marconi Official Gramophone Records.**

For self-tuition in receiving Morse Signals. Price 3/- each, double-sided. (Postage 8d.)

**The Calculation and Measurement of Inductance and Capacity.**

By W. H. NOTTAGE, B.Sc. Invaluable to all engaged in Telegraph Engineering. Indispensable to the Wireless Engineer, Student and Experimenter. Price 3/6 net. (Postage 5d.)

**A Short Course in Elementary Mathematics and their application to Wireless Telegraphy.**

By J. WILLIS. To Students in Wireless Telegraphy, as well as those engaged in the practical application of this Science, this book should prove of immense value. Price 3/6 net. (Postage 6d.)

**The Maintenance of Wireless Telegraph Apparatus.**

By P. W. HARRIS. An up-to-date Manual, full of practical hints and explanations. Diagrams of all ship installations, from  $\frac{1}{2}$  kw. to 5 kw. Price 2/6 net. (Postage 4d.)

**Dictionary of Technical Terms used in Wireless Telegraphy.**

By HAROLD WARD. 2nd Edition, Revised and Enlarged. Vest Pocket Size. Contains over 1,500 definitions. Price 2/6 net. (Postage 2d.)

**Test Questions and Answers on Wireless Telegraphy.**

Invaluable for self-examination.

Series 1. THE ELEMENTARY PRINCIPLES OF WIRELESS TELEGRAPHY. Part 1.

Series 2. COVERING THE GROUND FOR THE POSTMASTER-GENERAL'S EXAMINATION.

Series 3. ELEMENTARY PRINCIPLES OF WIRELESS TELEGRAPHY. Part 2.

Price 2/- net. (Postage 3d.) Questions or Answers.

**Map of the World, showing the Wireless Stations.**

1918 Edition. Mounted on Linen, printed in three colours and bound in Cloth Folder. Price 2/- net. (Postage 3d.)

**Armature Model for 1½ kw. Rotary Converter.**

Shows every Winding of the Converter Armature from start to finish. Price 1/- net. (Postage 3d.)

**Morse Made Easy.**

By A. L. RYE (2nd Lieut., R.G.A.). Linen backed, for rapidly learning the Morse Code. Price 3d. net, or post free 3½d.

**Morse Code Card.**

Contains full alphabet, with punctuation marks, figures, abbreviations and contractions. Price 2d., post free.

**Bound Volume, No. 5. The Wireless World.**

Bound in cloth, with full index. Price 10/- net. (Postage, inland, 9d.; abroad, 1/4)

**Binding Cases for Volume 5 of The Wireless World.**

Price 2/6 net. (Postage 3d.)

FOR PARTICULARS OF OTHER PUBLICATIONS SEE PAGES XX, XXVIII

*Please mention "The Wireless World" when writing to Advertisers.*



## Sir Eric Geddes at 10, Downing Street.

At the meeting held at 10, Downing Street, on behalf of Lady Dimsdale's scheme to provide a Memorial Hostel in London for Men and Boys of the Merchant Service, under the auspices of the British & Foreign Sailors' Society, the First Lord pointed out that the continuance of the Society's work is one of the most urgent of Peace needs. No armistice will ever end the fight against wind and sea in which every Merchant Seaman is a combatant.

The world-wide provision made by the British & Foreign Sailors' Society for the comfort and welfare and recreation, for the spiritual, physical and intellectual needs of these gallant men must be not only continue but extended.

*Will you help by sending a donation?*

### PLEASE SEND WHAT YOU CAN AFFORD

In aid of our world-wide work to SIR FREDERICK GREEN, J.P., Hon. Treasurer, British & Foreign Sailors' Society, Wakefield House, Cheapside, London, E.C.2.

# BRITISH AND FOREIGN Sailors' Society

*(Including the Port of London Society, founded 1818, incorporated 1905).*

General Secretary: **Rev. T. EYNON DAVIES.**

Bankers: **THE BANK OF ENGLAND.**

**JUST PUBLISHED.**

## The Problems of Agility

(A summary of the laws governing speed in reiteration and succession ; for pianoforte and organ students and for Telegraphists, Wireless Operators and Typists).

By

**TOBIAS MATTHAY**

Professor of the Pianoforte at the Royal Academy of Music  
and Principal of the Tobias Matthay Pianoforte School.

EXTRACT FROM AUTHOR'S PREFACE :—

*"It having been brought to my ears that certain wireless officers of a squadron of H.M. Navy had found the "Act of Touch" of immediate help in their work, I felt it might be doing a service to such, and others, if I summarised in concentrated form the laws governing agility in utterance."*

Of all Music Dealers, or post free **1s. 3d.** from the Publishers.

**THE ANGLO-FRENCH MUSIC COMPANY, LTD.**  
31, York Place, Baker Street, W.1.

*Please mention "The Wireless World" when writing to Advertisers.*



# HARVEYS

Harvey Robertson

**17 London Street**  
(Facing Fenchurch Street Station)

HOSIERY DEPT., 15 London St.  
OUTFITTING DEPT., 16 London St.,  
**LONDON, E.C.3**

TELEPHONE AVENUE 2200.

*Business hours, 9—5.*  
*Saturdays, 1.30.*

Book to Mark Lane or Fenchurch Street Stations  
**TAILORS, OUTFITTERS,  
HOSIERS, AND TRUNK  
MAKERS**



UNIFORM SUIT



BRIDGE COAT



MESS SUIT



PATROL SUIT

## SPECIAL PRICES FOR WIRELESS OPERATORS, ALL RANKS.

- Uniform Serge Suit, good quality, gold lace and buttons, complete ... .. 105/-
- Superfine Cloth Suit, best quality, gold lace and buttons, complete ... .. 168/-
- Bridge Coat; or Naval Warm, gold straps and buttons, complete ... .. 84/-
- Naval Cloth Cap, Standard Badge, complete ... .. 20/-
- 1st Wireless Cuffs 11/-, Straps 5/-
- 2nd " " 10/-, " 4/-
- 3rd " " 5/-, " 3/-
- Standard Badges, all metal ... 12/6
- " Embroidered Wreath 15/-
- Buttons, Coat Size per dozen 3/-
- " Vest " " " 1/6

**OILCOATS, NAVAL BELTED COATS,  
WHITE SUITS, AND EVERYTHING  
FOR NAVAL WEAR.**

# HARVEYS'

Facing Fenchurch Street Station.

**ACKNOWLEDGED TO BE THE BEST HOUSE FOR THE WIRELESS OPERATOR.**



# MARCONI UNIFORMS

**O**PERATORS are well advised to purchase their Uniform and Gear from a House of standing and repute.

Admiralty approved cloths, correct in shade, properly cut and fitted, smart in appearance and exact in every detail are our chief features.

Every Marconi Officer's requirement kept in stock, ready for use.

The New Pattern Marconi Braid now being used.

Our Price List and advice is at your service.

## BOYD BROTHERS LIMITED

*Uniform Tailors & Admiralty Contractors,*  
"Howard House," 51 and 53 JAMAICA ST.,  
GLASGOW

No Connection with any other Firm  
of Similar Name.

Telegrams—"UNIFORMS, GLASGOW."  
Telephone—CENTRAL 1557.

## The London Telegraph Training College, Ltd.

TELEPHONE:  
WESTERN 2696.

Morse House, Earl's Court, S.W.

ESTABLISHED  
26 YEARS.

OFFICIALLY RECOGNISED BY THE WAR OFFICE AND POST OFFICE AUTHORITIES.

### CABLE AND WIRELESS TELEGRAPHY.

**P**ARENTS desirous of placing their sons in either of the above Services and of affording them the best training facilities should apply for particulars of Courses and the methods of instruction which place this Institution in the first rank. **Cable Telegraphy** offers at the present time excellent prospects to youths from 15 years of age and upwards, and **the College has exclusive facilities** for obtaining posts for qualified students in the leading Cable Companies at **commencing salaries** of £140 to £200 per annum, with yearly increments of £12 to £25, with ultimate possibilities of obtaining positions as Supervisors, Assistant Superintendents, Managers, etc.

**In the Wireless Telegraph Service** the commencing remuneration at the present time is approximately £150 per annum, and Operators, when qualified by obtaining the Postmaster-General's Certificate of Proficiency, are nominated by the College for appointments.

*No Correspondence Classes or Branches.*

### DAY AND EVENING CLASSES.

*An Illustrated Prospectus containing all information will be forwarded on application to*  
THE SECRETARY (Dept. H), 262 Earl's Court Road, Earl's Court, London, S.W.5.

# Weston Miniature Precision D.C. Instruments.

MODEL 268.



**T**HIS Model normally indicates amperes, but upon pressing the contact button the pointer indicates volts so long as the button is held down.

Volt-Ammeters are very useful in all cases where space is limited or where first cost is a material factor.

The Switchboard form is well adapted for use in electrolytic work, charging and discharging small batteries, and for service in connection with D.C. ignition systems.

It is suitable for all classes of work in which a single instrument is sufficient for indicating either potential difference or current.

The List Price of this Model is **£3 12s.** in all standard ranges.

Model 268 Switchboard Volt-Ammeter.

For full particulars write for List D 3.

## Weston Electrical Instrument Co.,

Audrey House, Ely Place, Holborn, E.C.1

Telephone: Holborn 2029.

Telegraphic and Cables: "Pivoted, London."

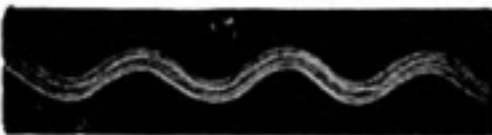

THERE IS  
NO  
**BETTER  
VALUE**

offered in

**UNIFORMS**

and

**OUTFITS**

FOR MARCONI  
SERVICES.

## MARCONI UNIFORMS.

ESTD.  
1840.

UNIFORM SUITS, Serge,  
lace and buttons complete,  
from 63/-

WHITE SUITS, from 12/6

CAP AND BADGE,  
from 9/6

TERMS—CASH.

SAMPLES AND PRICE LIST  
POST FREE.

Telephone: 139 Central.



**SELF & SON, 79 Fenchurch St.,**  
& RAILWAY PLACE, opposite Fenchurch St. Station,  
LONDON, E.C.





## Alternating and Continuous Current **GENERATORS AND MOTORS**

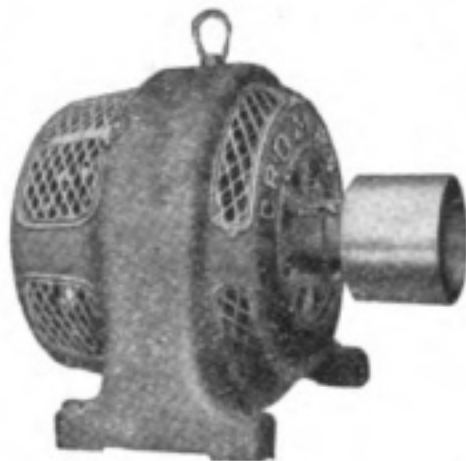

**GENERATORS & SELF-CONTAINED  
OIL AND STEAM GENERATING PLANTS  
FOR WIRELESS AND SHIP LIGHTING  
BATTERY CHARGING, &c.**

Also Manufacturers of

**HIGH FREQUENCY MACHINES**

**BOOSTERS      SWITCHGEAR      ARC LAMPS  
CONVERTERS      INSTRUMENTS      PROJECTORS**

PROTECTED TYPE C.C. MOTOR

PROMPT DESPATCH.

# **CROMPTON & CO., Ltd.**

Telegrams:—  
Crompton, Chelmsford

**CHELMSFORD.**

Telephone —  
161 Chelmsford  
(3 lines)

# **COUBRO & SCRUTTON**

**Head Office: 18, Billiter Street, London, E.C.**

Telegraphic Address: Coubro, Fen. London.

Telephones: East 7, 716, 717.

Makers of

**Wireless Masts and Accessories,  
Engineers and Smiths, Founders,  
Mast Makers and Riggers.**

Contractors to: Admiralty, War Office, India Office, and  
Colonial Governments.

DEMY 8vo.

Bound in best cloth

# STANDARD TABLES AND EQUATIONS IN RADIO TELEGRAPHY

By BERTRAM HOYLE, M.Sc. TECH., A.M.I.E.E.

**PRICE 9/- NET.      Postage 6d. extra**

Formulae, Equations and Tables for use in every  
branch of Wireless Engineering and Research

*Published by* THE WIRELESS PRESS, LTD.  
MARCONI HOUSE, STRAND, W.C.2

## A. W. GAMAGE L<sup>td.</sup>      HOLBORN LONDON, E.C.1

SPECIALISTS IN TELEGRAPHIC APPARATUS

Wireless Apparatus  
can only be supplied  
to authorised  
persons.



**Double Headband  
Receiver** (as illustration).  
Double Pole Telephone  
Type, wound to 40 ohms,  
each earpiece complete  
with 5 ft. green cords.  
Price **17/6**. Postage 4d.

### THE "NAROH" TUNED BUZZER

Patent No. 101171/16

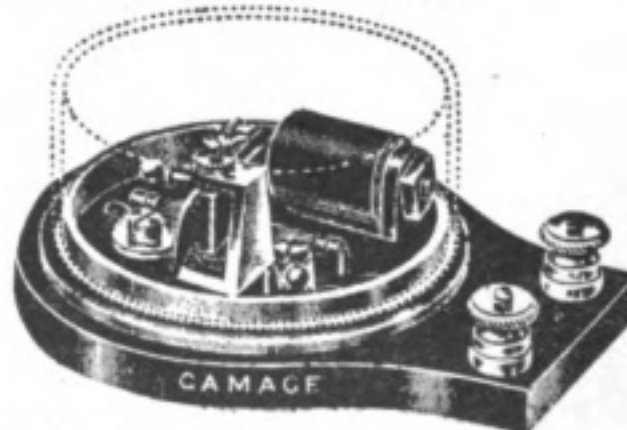

This instrument, the result of exhaustive experiments, will operate continuously at constant amplitude without changing its periodicity, and the note is instantly variable by the movement of a cam. A pure musical note with a range of three octaves can be obtained. Sparking at the contact points is entirely eliminated by a small graphite rod which can be shunted either across the coil or the platinum contacts, and if desired cut out entirely. As a laboratory instrument, where constancy and reliability are essential, this Buzzer is invaluable.

Price **37/6**

Mounted on polished ebonite base, with brass cover and glass top. Size over all  $4\frac{1}{2}$  by  $3\frac{1}{2}$  in. Weight about 15 ozs.

**IN STOCK  
BUZZERS, Keys  
Sounders, etc.**



### Single Headband Receiver

(as illustration), double  
pole, Telephone Type,  
wound to 80 ohms resist-  
ance. Complete with 5 ft.  
green cords. Price **10/6**.  
Postage 4d.

Please mention "The Wireless World" when writing to Advertisers.





**MARCONI OUTFITS**  
**NAVAL UNIFORMS.**  
**OFFICERS' SERVICE KIT.**  
 Blue Serges & Naval Cloths guaranteed to stand  
**SUN OR SEA**  
**ALL STUDENTS from ANY COLLEGE** Requiring Uniform  
 should pay us a visit. Inspection and Price List Free.  
*Enquiries from members of the Marconi Company will convince  
 you that we are recommended for Cut, Workmanship and Finish.*

**OUR MUFTI DEPARTMENT**  
 is complete with all the latest novelties and designs in **Suitings and  
 Overcoatings**, which can still be offered at our usual **Moderate Prices.**

**URGENT ORDERS EXECUTED IN 48 HOURS.**  
 Officers' Trench Coats & British Warms ready for Immediate Wear.

**J & H ELLIS**  
*Civil, Naval and Military Tailors,*  
**200 & 201 STRAND, LONDON, W.C.**  
 FACING LAW COURTS.

**Cost**



That the minor saving attached to the use of inferior products is false economy is never more strongly illustrated than on the question of insulating varnishes and compounds. We have never claimed cheapness as a feature of Standard Insulating specialities, because we know that so-called "cheap" productions spell failure. We do, however, claim for Standard Insulating Varnishes and compounds that they are considerably cheaper in the long run than any other productions the initial cost of which is less.

**STANDARD**  
**INSULATING**  
 Varnishes & Compounds

Standard insulating specialities are regularly used by the leading electrical manufacturing firms, lighting and power stations, railways, tramways, etc., which constitutes definite proof of their practical utility.

Catalogue, and Expert advice where necessary from:—  
**PINCHIN, JOHNSON & CO., LTD.,**  
 MINERVA HOUSE, BEVIS MARKS, LONDON, E.C.3

**Scientific Appliances**

**ALL MATERIALS FOR ELECTRI-  
 CAL, MAGNETIC, OPTICAL, and  
 . . EXPERIMENTAL WORK. . .**

INSULATED WIRES and RESISTANCE  
 WIRES of all sizes. SOLENOIDS, RELAYS,  
 EBONITE and SUNDRIES.

LENSES, PRISMS, MIRRORS for  
 making Microscopes, Telescopes, etc.

Our Famous WIMSHURST and other STATIC  
 MACHINES. High-Note BUZZERS, KEYS  
 and COILS of all forms.

ODD and SECONDHAND P.O.  
 INSTRUMENTS, GALVOS, and  
 APPARATUS at One-Third Cost.

**BIG STOCK OF EVERYTHING EXPERIMENTAL**

Call and inspect or write for new war-time list,  
 post-free Twopence.

FIFTY YEARS' EXPERIENCE. GOODS FORWARDED  
 TO ALL PARTS.

**Scientific Appliances**  
 (DALE and HOLLINS)  
 11-29 Sicilian Av., London, W.C.1

Established 1882.

Telephone 182 Hop.

# W. MACKIE & CO.

## The Palace Engineering Works

129, 131, 133, Lambeth Road,  
LONDON - - S.E.1.

---

*Contractors to the Admiralty, War Office,  
and Air Force.*

---

**Electrical & Mechanical Engineers.**

---

**MANUFACTURERS of:**

MARCONI'S WIRELESS DISC DISCHARGERS  
 ROTARY CONVERTERS                      DYNAMOS  
 ELECTRIC MOTORS                          TRANSFORMERS  
 BOOSTERS

**Complete Electric Light Installations**

for COUNTRY HOUSES and SHIPS.

AN EFFICIENT STAFF FOR REPAIRS.

---

Inventors' ideas carefully and skilfully carried out from  
 the preparation of detailed drawings to the completion  
 of the finished article.



Write for Booklet  
W.W. and self-  
measurement Form.  
Post Free.

\*Phone . . . Brixton 780  
Closed Wednesday at 1 o'clock

# A Personal Word to Marconi Operators

Is the price paid the *only* thing that counts? Or do you prefer a Real Indigo-Dyed Cloth Uniform finished in first-class style with Best Quality Gold Braid and Untarnishable Buttons at such a *reasonable* figure that your future orders are assured? If so, call and talk the matter over and place a trial order with

*P. Bryman*  
THE WIRELESS  
OPERATOR'S TAILOR.

5 Stockwell Road, CLAPHAM, S W.9.

(Opposite Tube Station, Stockwell)

**ENTER THE WIRELESS SERVICE**  
and see the World.

These are the only Schools in Great Britain fitted with complete standard Marconi, Poulsen and Telefunken Installations.

Day and Evening Classes. Complete Course for the Postmaster-General's First-Class Certificate. At two recent examinations 100 per cent. of our Day Students obtained the Postmaster-General's FIRST-CLASS Certificate of Proficiency in various systems

**NORTH-EASTERN SCHOOLS OF WIRELESS TELEGRAPHY**  
22 Blenheim Terrace, LEEDS.  
Central Chambers, High Street, SHEFFIELD.  
18 Eldon Square, NEWCASTLE-ON-TYNE.

WRITE NOW FOR ILLUSTRATED PROSPECTUS.

## Officine Elettro-Meccaniche

SOCIETA ANONIMA  
£4,000,000 interamente versato

**RIVAROLO LIGURE (ITALY)**

**WATER POWER TURBINES**  
PELTON WHEELS :: REGULATORS

**PUMPING MACHINERY**  
of all types and for every service

**ELECTRIC MOTORS**

**HOISTING MACHINERY**



Cranes of every description. Capstans, Lifts, etc.

**KINDLY SEND US YOUR ENQUIRIES.**  
Full Illustrated Catalogues and particulars on application.



# Marconi Wireless Telegraph Installations.

---

---

Enquiries invited for Wireless Telegraph Installations for communication over any distance, in any part of the World.

---

## PORTABLE APPARATUS FOR ARMY PURPOSES.

---

In addition to Installations, Special Apparatus has been designed for many purposes, amongst others:—

APPARATUS FOR ACTUATING FOG SIGNALS BY WIRELESS TELEGRAPHY.

SELF-CONTAINED RECEIVERS FOR THE RECEPTION OF TIME SIGNALS.

WIRELESS COMPASSES TO ASSIST NAVIGATION.

PRACTICE BUZZERS FOR INSTRUCTION IN TELEPHONE MORSE SIGNALLING.

PORTABLE WAVEMETERS,  
DECREMETERS INDUCTION COILS,  
etc., etc.

---

Write for Pamphlets describing above (mentioning requirements).

---

---

**MARCONI'S WIRELESS TELEGRAPH COMPANY, LTD.,**  
MARCONI HOUSE, STRAND, LONDON, W.C.2.

Telephone : 8710 CITY

Telegrams : EXPANSE, ESTRAND, LONDON.

# MARCONI

---

## WIRELESS

### Telegraph Apparatus

*for the*

### Mercantile Marine

*Stations for Passenger, Cargo and other Vessels supplied, installed and operated under Yearly Maintenance Contract by*

**THE MARCONI INTERNATIONAL MARINE COMMUNICATION CO. LTD.**

Full particulars upon application to the Company's Head Office at  
**MARCONI HOUSE**  
**STRAND, LONDON, W.C.2**

Telephone: City 8710 (10 lines).  
 Telegrams: "Expense Estrand, London."

**LIVERPOOL :**

*Agents:*  
**JOSEPH CHADWICK & SONS**  
 601, Tower Building, Liverpool  
 Telephone: Central 487

**GLASGOW :**

*Agents:*  
**MACNAUGHTAN BROS.**  
 175, West George Street, Glasgow  
 Telephone: Central 3107

**NEWCASTLE-ON-TYNE :**

**THE MARCONI INTERNATIONAL MARINE COMMUNICATION CO. LTD.,**  
 Milburn House, Newcastle-on-Tyne. Telephone: Central 1125.

**CARDIFF :**

**THE MARCONI INTERNATIONAL MARINE COMMUNICATION CO. LTD.**  
 8, New Street, Cardiff.  
 Telephone: Cardiff 1501

**SOUTHAMPTON :**

**THE MARCONI INTERNATIONAL MARINE COMMUNICATION CO. LTD.**  
 Oxford Ho., Oxford St., Southampton.  
 Telephone: Southampton 1818

## LIVERPOOL VICTORIA FRIENDLY SOCIETY.

CHIEF OFFICE—ST. ANDREW STREET, LONDON, E.C.4

Claims Paid... ..	£13,000,000
Invested Funds ... ..	£7,400,000
Annual Income ... ..	£2,250,000
Invested in War Loan ... ..	£2,250,000
Paid in War Claims, nearly...	£700,000

**LIFE AND ENDOWMENT ASSURANCES AT POPULAR RATES.**

Liverpool Victoria Approved Society. — Our numerous Branch Offices and Agents throughout the Kingdom transact National Health Insurance.

ARTHUR HENRI, *Secretary.*

## THE ZODIAC

THE SUBMARINE  
CABLE-SERVICE PAPER.

News from the Cable Stations and Ships, illustrated with many interesting photographs and drawings.

Monthly, 6d. ; or 6s. per annum,  
post free to any part of the world.

THE ZODIAC PUBLISHING COMPANY, LTD.  
Electra House, Finsbury Pavement, London, E.C.

OAK FLOORINGS

HARDWOODS FOR HIGH-CLASS JOINERY

## C. B. N. Snewin & Sons, Ltd.

BACK HILL

LONDON, E.C.

## TOOLMAKERS and STAMPERS

SANDS & GRAHAM, Ltd.

48, Miller Street, Glasgow,

and

234, Icknield Street, Birmingham.

Telegrams:  
"Bustle," Glasgow.  
"Bustle," Birmingham.

Code:  
A B C 5th Edition  
Marconi International



*Write to-day  
for  
Complete List  
of  
Signalling  
Instructional  
Instruments.*

## A New Instrument for Rapid Learning

Many instruments for teaching the Morse Code have been introduced from time to time, but their principal drawback has been that they tend to encourage slowness by teaching the learner to first think of the Morse Signs in their component parts instead of in their entirety. The Scribo-Morse enables the learner to get his ear accustomed to the Morse Sounds in *their entirety right from the commencement*. It eliminates the necessity for "consciously" thinking in dots and dashes and enables him to do so *subconsciously*. Thus the

## SCRIBO-MORSE

simplifies learning by making the process in a sense automatic. The student associates the sound he hears with the particular letter, and he can repeat it the moment he hears it. Scribo-Morse is the quickest way to reach the Standard Test rate; therefore it will save you money.

The price of the Scribo-Morse is ... 12/6, postage 4d. in G.B.  
Complete with Buzzer, Battery and Wire 19/6, .. 9d. ..

**GRAHAM & LATHAM, LTD.**

**Military Engineers.**

(Dept. W.2) 27, LOTS ROAD, CHELSEA, LONDON, S.W.10.





## A WIRELESS TRAINING

**A**T A CITY SCHOOL is a guarantee of the best possible Wireless training. Efficient staff and thoroughly up-to-date methods. The Schools at MANCHESTER, NOTTINGHAM and BIRMINGHAM are each equipped with a standard 1½ K.W. Ship Set, etc. Day and Evening Classes, also Postal Course. Students may join at any time. Fees moderate.

**A**N ELECTRICAL COURSE has now been arranged at the Manchester School for training young men as Electricians to meet the large demand for this class of skilled artisan. Special terms for Discharged and Disabled Soldiers and Sailors. Full particulars and prospectus for Wireless or Electrical Course on application to the  
PRINCIPAL: MR. J. R. HALLIWELL,

**CITY SCHOOL of WIRELESS TELEGRAPHY**  
61 HIGH STREET, MANCHESTER (Tel. CITY 5210).  
County Chambers, 66½ Corporation St., Birmingham  
Guardian Chambers, 4 Bridlesmith Gate, Nottingham

# MERCANTILE MARINE STANDARD UNIFORMS

*Made from the Regulation*

## ADMIRALTY "P.N." CLOTHS

AT GOVERNMENT CONTROLLED PRICES

Call or Write for Particulars :: :: Satisfaction Guaranteed

# PATERSON'S

J. & M. PATERSON, LIMITED

HIGH-CLASS TAILORS AND NAVAL OUTFITTERS

## 301. Argyle Street, GLASGOW

Telephone—Avenue 2995.

**ESTABLISHED 1818.**

Telegrams: Millraysom, London.

Contractors to H.M. Government and the Principal Steamship Lines, etc.

# MILLER, RAYNER & HAYSON, L<sup>TD.</sup>

## Naval, Military and Shipping Outfitters.

*OFFICERS' UNIFORMS FOR ALL  
BRANCHES OF THE SERVICE.*

**Complete Outfits for the Navy, Army,  
and the Mercantile Marine.**

**Regulation Uniform for Marconi  
Officers.**

Head Offices—**110, Fenchurch Street, LONDON, E.C.3.**

**LIVERPOOL—24, Lord Street.**

**SOUTHAMPTON—35/6, Oxford Street.**

## SEA, LAND and AIR

THE AUSTRALASIAN MONTHLY  
JOURNAL  
FOR

The Navy . . . . .  
The Mercantile Marine  
Aviation . . . . .  
Radio-Telegraphy and  
Radio-Telephony. . . . .

**Price 1/- post free.**

Published by  
the WIRELESS PRESS, Ltd., Sydney, N.S.W.

Sole European Agents:  
the WIRELESS PRESS, Ltd.  
MARCONI HOUSE,  
Strand, London, W.C.2.

### "The Model Engineer"

A splendid paper for young Engineers, Apprentices, Students and Amateurs interested in Mechanics, Electricity and Model Making. It contains practical articles by experienced writers on Electrical and Mechanical subjects, Locomotives, Motor Cycling, Model Aeroplanes and Wireless Telegraphy.

*Published every Thursday, 4d. post free.*

### "Junior Mechanics and Electricity"

The paper for beginners of all ages in Mechanics, Electricity and Model Making. All the articles are written in simple language so that everybody can read and understand them. It is well illustrated. There is also a Queries and Replies section, from which much valuable information can be obtained.

*Published on 1st of each month.  
4d. Post free.*

### SOME USEFUL BOOKS.

Practical Lessons in Metal Turning ..	Small Accumulators..	10jd.
Engineering Mathematics Simply Explained .. 23	Electric Bells & Alarms	10jd.
Practical Dynamo and Motor Construction 19	Electric Batteries ..	10jd.
Practical Induction Coil Construction 1/9	Small Dynamos and Motors..	10jd.
Petrol Motors Simply Explained .. 1/9	Induction Coils for Amateurs ..	10jd.
Workshop Wrinkles and Recipes .. 1/9	Small Electric Motors	10jd.
	Alternating Currents	10jd.
	Windmills and Wind Motors..	10jd.
	Wireless Telegraphy Simply Explained ..	10jd.

Every Boy's Book of Electricity, 3d.

Every Boy's Book of Engines, 3d.

Book List sent post free on receipt of card.

**PERCIVAL MARSHALL & CO.,**  
66, FARRINGDON STREET, LONDON, E.C.

Please mention "The Wireless World" when writing to Advertisers.

## The OHMER INSULATION TESTING SET (Cox's Patent).

This is the lightest, cheapest and best instrument of its kind on the market. It consists of an Ohmeter and Generator mounted in one case. The Ohmeter is of the Electrostatic type, giving extreme lightness. Absolutely unaffected by external fields. It reads directly in Megohms and is independent of the voltage or speed of the generator.



**NALDER BROS. & THOMPSON, LTD.,**  
**97a, Dalston Lane, LONDON, E.8.**

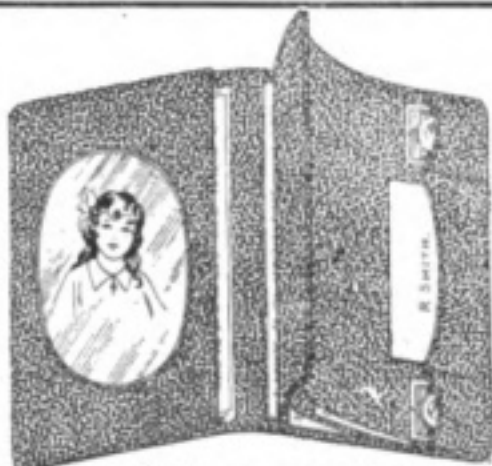

"The London"

## TWO GOOD WALLETS

Solid Leather, size  $6\frac{1}{2} \times 4$  when folded

"THE LONDON"  
 With space for photograph.  
 Two roomy pockets.  
 Two pockets for Treasury Notes.  
 Space for cards & postage stamps.

"THE YORK."  
 With pull-out photograph holder.  
 One tight pocket for Treasury Notes.  
 One gusset pocket for letters.  
 Card and stamp pockets.

Price, either pattern, by registered post, 17/6 each.

## EDEN FISHER & CO., LTD.

95, 96 & 97 Fenchurch Street, London, E.C.3

# Willcox's

WRITE FOR  
 ILLUSTRATED LISTS.

W. H. Willcox & Co., Ltd.  
 32 to 38, Southwark Street, LONDON, S.E.1.

UNDERTAKE SUPPLY OF ALL  
 REQUISITES FOR ENGINE ROOMS,  
 POWER PLANT, MACHINE SHOPS, &c.



Our Specially Refined Lubricants  
 are in use on every class of  
 Machinery.

Registered "NIPHAN" Trade Mark.

## WATERTIGHT PLUGS and Cable Couplings

To Meet Home Office Requirements  
 5 to 250 Amps      500 Volt Circuit

As used by H.M. War Office, Electric Supply Cos.,  
 Railway Cos., Marconi's Wireless Telegraph Co.

**SIMMONDS BROS., Ltd**  
 4, 6 & 8 Newton St., Holborn, W.C

Phones: 2900 Gerrard,  
 12061 Central  
 Telegrams: 'Niphen, London'  
 Patented in England & Abroad

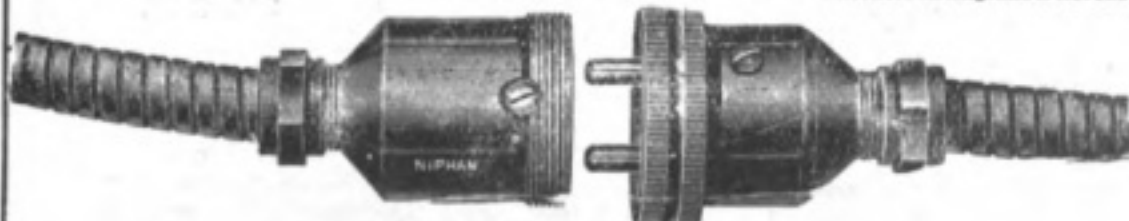

Coupling Connecting Cables.



3-Way Tee



THE  
**WIDNES**  
**FOUNDRY**

COMPANY, LIMITED. ESTABLISHED 1841

---

**B**UILDERS *of* STEEL BRIDGES,  
PIERS, ROOFS, GIRDERS, *and*  
ALL KINDS *of* CONSTRUCTIONAL  
STEEL AND IRON WORK

---

Electrical Transmission Masts

---

CHEMICAL PLANT Manufacturers  
SEGMENT AND PIPE FOUNDERS  
CASTINGS *of* EVERY DESCRIPTION

Contractors to the Admiralty, War Office,  
India Office, and Crown Colonies. The  
leading British, Foreign and Indian Railways

---

*Works:*  
WIDNES, LANCS.

*Telegrams:* "Foundry, Widnes."

*Telephone:* No. 225 Widnes.

*London Agents:*  
GEORGE F. WEST & CO.,  
13 VICTORIA STREET,  
LONDON, S.W.

*Telegrams:* "Westeelite, London."

*Telephone:* 4340 Victoria.

